

WHATCOM COUNTY
SHERIFF'S OFFICE

BILL ELFO
SHERIFF



PUBLIC SAFETY BUILDING
311 Grand Avenue
Bellingham, WA 98225-4038
(360) 778-6600

EMO TO: County Executive Satpal Singh Sidhu
THROUGH: Brad Bennett, Finance Manager
FROM: James Triplett, Investigations and Support Services Lieutenant, WCSO
Rodger Funk, Investigations and Support Services Chief, WCSO
DATE: July 24, 2023
RE: Recommend to Award Bid #23-34 – Rescue Boats

Background

Bids were duly advertised to for the purchase of two (2) rescue boats. The Sheriff's Office Marine Unit and Whatcom County Search and Rescue Volunteers will use these boats in the performance of county business for response to river and flood rescue operations.

Two (2) bids were received on Tuesday, June 27, 2023. West Coast Marine Services, located in Bellingham, submitted the lowest responsive and responsible bid, as noted below:

Bidder	Make & Model	Base Price (For 2 Boats)	Sales Tax (% Rate)	Total Bid Amount
West Coast Marine Services	Wooldridge – 18' Alaskan LT	\$96,233.64	\$8,468.56 (8.8%)	\$104,702.20
Technology International Inc	2023 Elestec Inlander Alum	\$217,000.00	\$18,662.00 (8.6%) ¹	\$235,662.00

¹ Sales tax was not noted on bid response; input destination-based rate of 8.6% for Total Bid Amount, per bid document.

Funding Amount and Source

Exhibit B of the 2023-2024 budget included \$90,000.00 in the General Fund on ASR #2023-6352 for this purchase. A subsequent Budget Transfer Request was approved on 07/26/23 for the additional funding needed for this purchase.

Requested Action

The Sheriff's Office requests the County Council and County Executive's approval to award bid #23-34 to West Coast Marine Services, in the amount of \$104,702.20.

Questions

Please contact James Triplett Ext. # 6725 if you have any questions or concerns regarding this request.

Recommendation

In accordance with WCC 3.08.030, I concur with this recommendation, and forward such to the County Council and County Executive for approval, per WCC 3.08.100(A).

Brad Bennett, AS Finance Manger

7/27/23
Date

Approved as recommended:

County Executive

Date of Council Action

**Whatcom County
 Bid #23-34
 Rescue Boats
 BID RESPONSE FORMS**

The bidder hereby acknowledges that they have read and understand all the equipment specifications and bidding requirements. The bidder also acknowledges that any bid submitted which does not meet the minimum specifications may be deemed unresponsive and rejected on that basis.

Unless otherwise stated, wherever in this solicitation an item is described by using a trade name, model number, catalog number, manufacturer name, or vendor name, it is intended that the words, "or equivalent/comparable substitution" apply. If a bidder proposes an alternate item, it must be clear, and include a complete description of the proposed alternate.

Printed literature and specifications describing equipment as offered must be included with the bid proposal. Any recent changes and features offered as standard or required for the intended use of the specified equipment will be supplied. All accessories required by these specifications shall be identical in quality and design to those normally supplied and installed for sale through regular commercial channels.

Please complete and include all pages of the Bid Response Form, References, Requested Brochures, and Copies of Warranties. Please print (in ink) or type all information on the Bid Response Forms, with exception to the signature field. Bidder may attach additional pages for comments on Minimum Specifications. Clearly reference to the applicable specification.

For: Two (2) Rescue Boats
 Submit Sealed Bids Before: 2:30 PM, Tuesday, June 27, 2023
 Deliver Bids To: Administrative Services Finance/Purchasing
 311 Grand Avenue Suite 503; Bellingham, WA 98225
 F.O.B. Delivery Point: Whatcom County Public Works
 901 W. Smith Road; Bellingham, WA 98226-9610

Make & Model Offered: WOOLDRIDGE BOATS 18 ALASKAN LT
 Base Price Each: \$ 48,116.82 Base Price for Two (2): \$ 96,233.64
 Sales Tax @ 8.8 %: \$ 8,468.56
TOTAL BID AMOUNT: \$ 104,702.20

Bidder acknowledges receipt of Addenda by checking the box(es): 1 2 3 4
 Prompt Payment Discount Offered: 30 DAYS POST DELIVERY = 5% DISCOUNT FOR \$5,135.11 SAVINGS
 Delivery After Firm Order Within: 45 DAYS
 Warranty Offered at No Additional Cost: SEE WARRANTY SECTION ON PAGE 6
(Please use additional pages if necessary)
 Warranty Period: SEE WARRANTY SECTION ON PAGE 6
 Warranty Coverage for Boat and Motors: SEE WARRANTY SECTION ON PAGE 6

WA STATE INTERLOCAL COOPERATIVE ACT 39.34

Other municipalities or political subdivisions may purchase the same equipment from the vendor over the subsequent time period for which the vendor is willing to honor the bid price. Yes No

OPTION FOR PURCHASING ADDITIONAL UNITS

The County may choose to purchase additional like units for up to two years following the date of award. Yes No

BIDDER IDENTIFICATION

Company Name: WEST COAST MARINE SERVICES INC
 Address: 1200 C ST
 BELLINGHAM, WA 98225
 Submitted By: MONTY SEIDEL GM - SALES & FINANCE
(Print Name & Title)
 Signature:  Phone: 360-676-8020
 Email: wcmssales@comcast.net Fax: 360-738-6002

**Whatcom County
Bid #23-34
Rescue Boats
BID RESPONSE FORMS**

These boats will be used in both fresh and salt water. The boats will be subject to extreme conditions to include swift water and flood response where maneuverability and hull integrity are paramount. Whatcom County provides marine safety patrols and emergency response in the county lakes, rivers, and along the shoreline of Whatcom County, Lummi Island, and north to Point Roberts, which is located on the west end of mainland British Columbia.

MINIMUM SPECIFICATIONS	MEETS SPECIFICATIONS? YES – NO – COMMENT
BASIC BOAT	
Boats must be of sufficient size to handle a minimum crew of two, with the ability to carry up to four additional passengers, plus their equipment	YES
Trailerable – Must include appropriately sized trailer configured for a conventional passenger tow vehicle	YES
Boat must be equipped sufficiently to meet Coast Guard approval requirements	YES
HULL	
Mono hull, 1/8" bottom and side gauge aluminum plate construction (min.)	YES
Length – 18-20' LOA <i>(swim step/diving platform or transom could add to length)</i>	Specify Length: YES 20'
Breadth – 7' BOA maximum	Specify Breadth: YES 80"
Depth – proportional to length & beam	Specify Depth: YES 21"
Welded center console with windshield and seat/storage in front of console	YES
Grab rails on each side of windshield	YES
Leaning post for driver with upholstered seat	YES
Transom ladder	YES
Easy access to all equipment that requires service and maintenance	YES
Diamond plate floors	YES
Welded bow eye and welded stern eyes	YES
Sacrificial anode for salt/fresh water	YES
Aluminum hand rails at bow and stern along the gunnel	YES
PROPULSION & CONTROLS	
One (1) four-stroke Honda, Mercury, Suzuki, or Yamaha outboard jet engine to match vessel; 65 Rated HP minimum	Specify Make & Model: HONDA BF90/65 JET
Fuel tank – 14 gallons (min.)	YES
RPM and hour display for engine data (min.)	YES
ABYC Compliant electrical system	YES
One (1) electric bilge pumps w/ auto/man/off switch	YES
EPA Compliant fuel and venting system	YES
One (1) marine grade group 27 AGM start battery	YES

**Whatcom County
 Bid #23-34
 Rescue Boats
 BID RESPONSE FORMS**

MINIMUM SPECIFICATIONS

**MEETS SPECIFICATIONS?
 YES – NO – COMMENT**

NAVIGATION & COMMUNICATION

LED Navigation lights YES

Navigation horn YES

OPERATIONAL EQUIPMENT

LED Headlight recessed in bow YES

One (1) fire extinguisher YES

Outfit kit including anchor w/ chain and rode, dock-lines, fenders, boat hook YES

PRESERVATION

All dissimilar metals isolated from one another through best marine practices YES

WARRANTY

Specify the minimum warranty on the following:

Structural hull **W.B. 24 MONTH GOVT WARRANTY EXCLUSIVELY THRU WEST COAST MARINE**

Motor **HONDA MARINE 36 MONTH GOVERNMENT NON-DECLINING WARRANTY**

Other (include description): **EZ-LOADER TRAILERS 24 MONTH WARRANTY**

MISCELLANEOUS

Three complete sets of keys YES

One set of service manuals, including major overhaul of all components, electrical and hydraulic diagrams, and parts YES

One copy of the Manufacturer's Statement of Retail Price (MSRP label) per unit YES

WEST COAST MARINE SERVICES INC.

1200 "C" STREET BELLINGHAM, WA 98225

PH (888) OR (360) 676-8020 FX (360) 738-6002 www.wcmarine.us wcmssales@comcast.net

Wooldridge Boats - Marlon Boats - Honda - Yamaha - EZ Loader

QUOTE

Name: WHATCOM COUNTY SHERIFF'S OFFICE - BID #23-34

Date: 6/20/2023

Address: 311 GRAND AVE

Price Valid Until: 9/20/2023

City, St, Zip BELLINGHAM, WA 98225

Quote Prepared By: MONTY

Phone:

Desired Delivery Date: ASAP

Fax:

Finance Rate:

E-Mail:

QUANTITY	DESCRIPTION	UNIT PRICE	TOTAL
2	WOOLDRIDGE BOATS 18' ALASKAN LT HULL	\$17,898.00	\$35,796.00
2	HONDA MARINE BF90/65 JET MODEL OUTBOARD	\$12,565.00	\$25,130.00
2	EZ-LOADER EZ90BS 14-18 2300 GALV TLR W/BUNK SLICKS & EXT. TONGUE	\$3,789.00	\$7,578.00
2	HONDA MARINE ENGINE RIGGING KIT W/TACH & HOUR	\$800.00	\$1,600.00
2	CENTER CONSOLE W/FOLDING WINDSHIELD & GRAB RAILS	\$2,287.00	\$4,574.00
2	15" x 15" STORAGE BOX FWD OF CONSOLE WITH CUSHION SEAT	\$515.00	\$1,030.00
2	SPLIT SPORT RAILS ON BOTH GUNNELS	\$1,349.00	\$2,698.00
2	15 GAL BOW MOUNT EPA COMPLIANT FUEL SYSTEM W/WATER FILTER	\$799.99	\$1,599.98
2	STANDARD SWIMSTEP WITH FOLDING LADDER AND GRAB RAIL	\$1,199.00	\$2,398.00
2	LEANING POST CUSHIONED SEAT W/STORAGE FOR OPERATOR	\$1,200.00	\$2,400.00
2	WELDED TRANSOM BRACKETS FOR ANODES & TRANSDUCERS	\$200.00	\$400.00
2	EXPLORER PAK - LED NAV LIGHTS, HORN & AUTO BILGE W/SWITCH PANEL	\$1,299.00	\$2,598.00
2	BOW MOUNT 19" VISION-X FLUSH MOUNT LED SEARCH LIGHT BAR	\$1,589.00	\$3,178.00
2	GROUP 27 AGM BATTERY UPGRADE W/BOX	\$550.25	\$1,100.50
2	LEE LOCK RIVER ANCHOR SYSTEM W/40# ANCHOR AND 75' LINE	\$725.00	\$1,450.00
2	DOCK KIT - FENDERS & LINES, DOCK LINES AND TELESCOPING POLE HOOK	\$187.00	\$374.00
2	LARGE B:C RATED FIRE EXTENGUISHER, MOUNTED	\$90.00	\$180.00
6	SPARE KEY SETS	\$9.21	\$55.26
2	HONDA MARINE FACTORY ENGINE SERVICE & PARTS MANUALS	\$146.95	\$293.90
2	LABOR - RIGGING, SETUP, PDI SEA-TRIAL AND DELIVERY	\$1,400.00	\$2,800.00
-2	HONDA MARINE GOVERNMENT REBATE	\$500.00	-\$1,000.00
Notes:		Sub-Total:	\$96,233.64
DELIVERY WITHIN 45 DAYS OF BID CONFIRMATION		Local Sales Tax - 8.8%	\$8,468.56
Customer Signature:		Total:	\$104,702.20



ALASKAN LT BROCHURE

20' Alaskan LT shown with option

Run shallow, run far. Alaskan LT will get you there.

For years, our customers asked us why we don't build a lighter duty entry level jet boat like many of the other stackable model boats out there. You know, one of those boats the "other guys" sold to big box stores and dealers everywhere. Well fact is, we've really prided ourselves on ultra-high quality handmade welded boats that are truly made one at a time, not mega dealer production style crafts like you see everywhere else.

It would have to carry on the 100 plus year family owned legacy of quality that we could proudly put our Wooldridge name on. Well friends, the wait is over. We introduced the perfect ultimate light model jet boat, tailor-made for running skinny shallow Alaskan rivers or chasing waterfowl thru the rain-swollen valleys and bogs during a wet fall day. Lengths of 16', 18' and 20' will feature a 5' bottom and of course as you would expect, our often imitated but never duplicated jet tunnel. For those who want that smaller jet hull, without sacrificing solid welded structural integrity, your search ends here.

Check out the Wooldridge Alaskan LT model!

BOAT SPECIFICATIONS

Beam	80"
Side Height	21"
Side Gauge	1/8"
Bottom Width	60"
Bottom Gauge	1/8"
Deadrise	9°
16' Weight	690 lbs.
18' Weight	740 lbs.
20' Weight	800 lbs.
Capacity(16' Only)	940 lbs.
16' Max Prop H.P.	65
16' Max Jet H.P.	65
18' Max Prop H.P.	70
18' Max Jet H.P.	140
20' Max Prop H.P.	90
20' Max Jet H.P.	150

WOOLDRIDGE LT ALASKAN

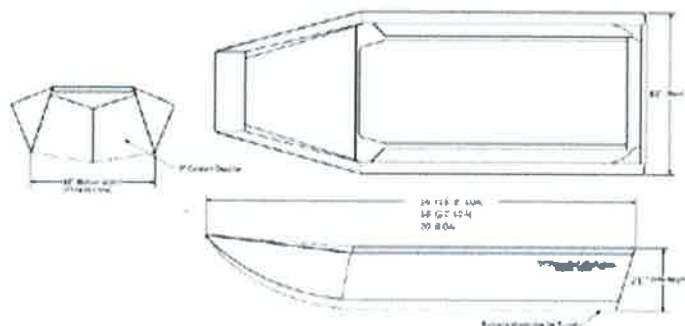

Wooldridge
Est. 1915

ALASKAN LT STANDARD FEATURES

- 4 Seating / Flotation boxes**
- Swim Step***
- .125 Diamond Plate floors
- Side Trays
- Welded bow and stern eyes
- Storage under front step deck

*On required sizes

- Diamond plate bow cap
- Recessed diamond plate step deck
- Lifetime Limited Hull Warranty to original buyer
- Wooldridge Full Support Structure System
- Full length under floor cable runs

**16' model only

- Exclusive Wooldridge Jet Tunnel
- Formed rib bottom, with 4 corrugations 2 on each side of keel
- Extended bottom trim plate
- U.S.C.G. Approved level floatation*

***18' model only



20' Alaskan LT shown with options



20' Alaskan LT shown with options



20' Alaskan LT shown with options



18' Alaskan LT shown with options



20' Alaskan LT shown with options



16' Alaskan LT shown with options



16' Alaskan LT shown with options

Wooldridge Boats exclusive jet tunnel offers the best in shallow water running and handling in

challenging river running conditions. The tunnel allows the jet foot to be raised for protection, a clean water feed and ram effect. It also provides traction for controlled and predictable performance in tight

CORNERS BETTER

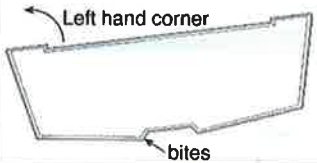

RUNS SHALLOWER

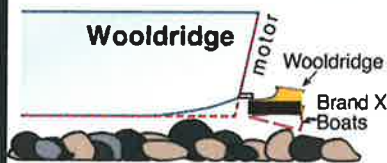

20' Alaskan LT shown with options

Wooldridge
Est. 1915

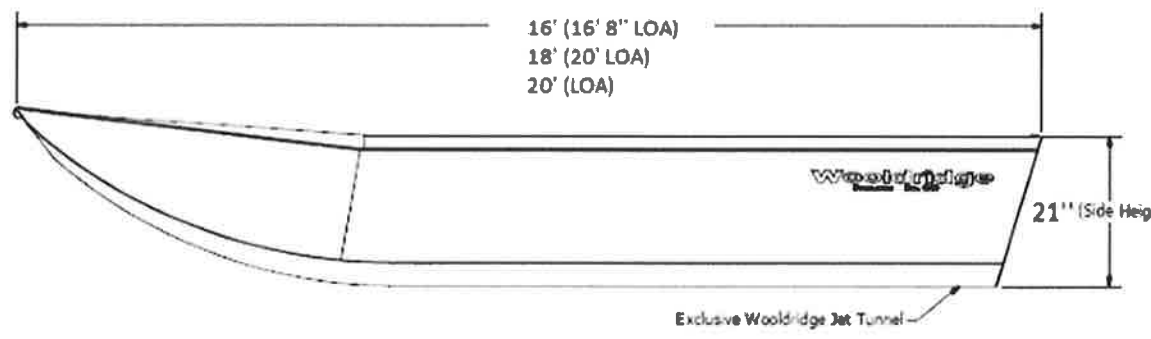
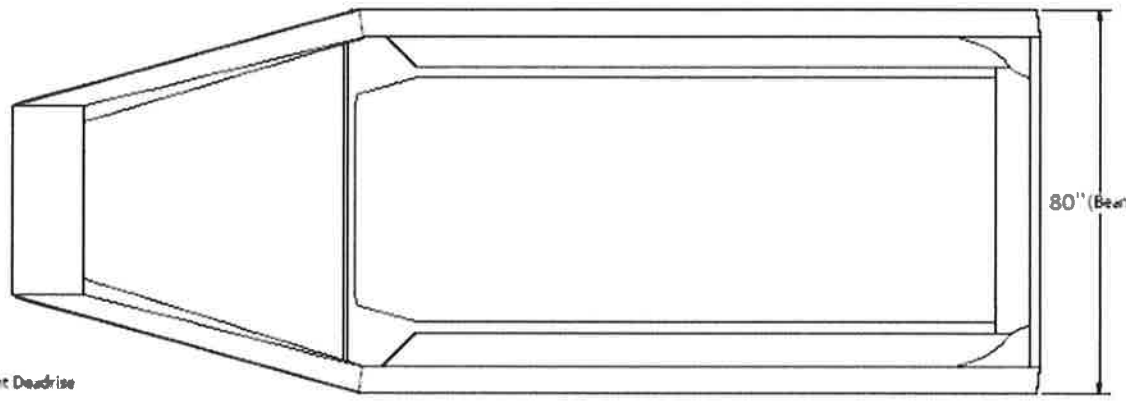
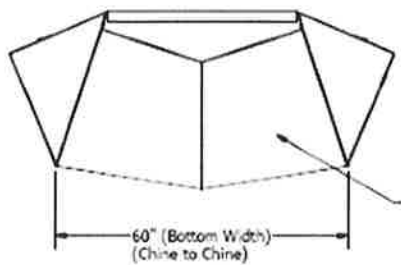

WOOLDRIDGE BOATS, INC.
LIMITED LIFETIME WARRANTY & INDEMNIFICATION

Wooldridge boats come with the following Limited Lifetime Warranty & Indemnification. Whenever used in this limited lifetime warranty and indemnification agreement (the "Agreement"), the following terms shall have the following definitions: (a) "Buyer" shall mean the first retail purchaser of the Product; (b) "Wooldridge" shall mean Wooldridge Boats, Inc.; (c) "Product" shall mean only the aluminum hull manufactured by Wooldridge and specifically excludes all other equipment, paint, vinyl and components (which may have separate coverage depending on the manufacturer).

Buyer's Obligations/Making a Claim. Within thirty (30) days of discovery of a defect in the Product, Buyer shall notify Wooldridge in writing at 1303 South 96th Street, Seattle, WA 98108. Prior to the authorization of any warranty repair(s), Wooldridge will require the Product to be returned to Wooldridge at the address set forth above or such other location as Wooldridge may direct in their sole discretion. The Buyer will be responsible to demonstrate they were the original purchaser of the Product. The Buyer will be responsible for all transportation, haulouts, loss of time, inconvenience, travel expenses, loss of use, launch, towing, storage and other expenses incurred in connection with warranty service. Wooldridge will then authorize such repair of defects under this Agreement, as Wooldridge in its sole discretion deems appropriate.

Wooldridge's Obligations. This Agreement applies to structural defects in material or workmanship in the Product, as determined by Wooldridge in its sole discretion, for the duration of Buyer's ownership of the Product. In no event shall the cost of such repair or rework exceed the actual cash value of the Product. Wooldridge will, within a reasonable time after notification as provided under this Agreement, exercise its option to repair a Product which shall be determined to have been defective in material or workmanship in Wooldridge's sole discretion. Wooldridge does not guarantee that repair of the Product will be completed within any specific time period. Wooldridge reserves the right to substitute models, change colors, specifications, designs, component parts, material, equipment or cease production of certain models of the Product at any time without notice. All parts replaced under warranty shall become the property of Wooldridge.

Warranty Exclusions. This warranty specifically does not apply to:

- Any Product that has been altered or modified other than as authorized by Wooldridge;
- Deterioration caused by overpowering or overloading according to the maximum horsepower specifications;
- Corrosion, electrolysis, zincing, paint, vinyl components, coatings, and UHMW (or similar) hull protection and fastening systems;
- Any transportation, launch, hauling, storage, loading or other expenses incurred in connection with warranty service;
- Any loss of time, loss of use, inconvenience, or loss of or damage to Buyer's personal property;
- Damage caused by Buyer's misuse, improper use, or failure to use an appropriate trailer, trailer tie down straps, or other appropriate securing and transportation restraints;
- Racing or competition use, modification of original parts, or abnormal strain;
- Lack of proper maintenance and off-season storage, installation of parts or accessories not approved by Wooldridge; or Buyer's failure to perform the periodic maintenance;

CUSTOMER'S COPY: LIMITED LIFETIME WARRANTY & INDEMNIFICATION

I understand that the warranty set forth above becomes effective upon the date of purchase by me of the Wooldridge boat described in the registration certificate, and that I should complete and return this registration certificate to Wooldridge at the time of sale of such boat to me. I understand that there is no other warranty provided by Wooldridge except as expressly set forth in writing above.

My failure to sign and return this voids all warranties.

Date purchased: _____

Boat Serial Number: _____

- Damage incurred as a result of accidents, collisions, contact with foreign materials, submersion, unreasonable use, abuse, vandalism, or tampering;
- Damage incurred as a result of growth of marine organisms;
- Acts of God;
- Boats used for governmental, business or commercial purposes;
- Damage caused by continued use after the defect is or should have been discovered;
- Any modification, repair, or alteration of a Product made without the authorization of Wooldridge or by any unauthorized third party or altered in any way;
- Deterioration caused by exposure to the elements or the use of cleaners or chemicals.

WOOLDRIDGE MAKES NO OTHER WARRANTY OF ANY KIND, EXPRESS OR IMPLIED. ALL IMPLIED WARRANTIES OF MERCHANTABILITY AND FITNESS FOR A PARTICULAR PURPOSE EXCEED THE OBLIGATIONS AND THE LIMITS STATED IN THIS AGREEMENT ARE HEREBY DISCLAIMED BY WOOLDRIDGE AND EXCLUDED FROM THIS AGREEMENT.

EXCLUDED FROM THIS AGREEMENT ARE ALL INCIDENTAL AND CONSEQUENTIAL DAMAGES INCLUDING BUT NOT LIMITED TO LOSS OF PROFITS OR INCOME, LOSS OF USE OF THE PRODUCT, EXPENSE IN CONNECTION WITH WARRANTY SERVICE, PERSONAL INJURY, OR DAMAGES TO PROPERTY.

BUYER AGREES TO DEFEND, INDEMNIFY, AND HOLD HARMLESS WOOLDRIDGE (INCLUDING ITS OFFICERS, DIRECTORS, OWNERS, AND EMPLOYEES) FROM AND AGAINST ANY AND ALL CLAIMS, DEMANDS, FEES (INCLUDING REASONABLE ATTORNEY'S FEES), CAUSES OF ACTION, OBLIGATIONS, DAMAGES, EXPENSES, AND LIABILITIES (AND TO REIMBURSE WOOLDRIDGE FOR THE SAME) ARISING FROM OR RELATING TO ANY HARM, PROPERTY DAMAGE, LIABILITY, PERSONAL INJURY, OR OTHER LOSS ATTRIBUTABLE IN WHOLE OR IN PART TO ANY ACT OR OMISSION OF BUYER. THE FOREGOING INDEMNIFICATION IS A MATERIAL PART OF THE CONSIDERATION RECEIVED BY WOOLDRIDGE.

THIS AGREEMENT SHALL APPLY IN ACCORDANCE TO THE LAWS OF THE STATE OF WASHINGTON. THIS DOCUMENT CONTAINS THE ENTIRE WARRANTY GIVEN BY WOOLDRIDGE AND THERE ARE NO TERMS, PROMISES, CONDITIONS, OR WARRANTIES, OTHER THAN THOSE CONTAINED HEREIN. NO ORAL OR WRITTEN INFORMATION OR ADVICE GIVEN BY WOOLDRIDGE, ITS DEALERS, REPRESENTATIVES, AGENTS OR EMPLOYEES SHALL CREATE A WARRANTY BY WOOLDRIDGE OR IN ANY WAY INCREASE THE SCOPE OF THIS AGREEMENT.

BF90



*BF75/90 and BF100
are inspired by the
Honda HR-V automobile.*



BF90/65 Jet
✓ 65hp at pump

Specifications

ENGINE

TYPE	4-Stroke SOHC 4 Cylinders
DISPLACEMENT	1496cc (91.4 cubic in.)
BORE & STROKE	73 x 89.4 mm
FULL THROTTLE RPM RANGE	5300-6300 RPM
HP RATING AT PROPSHAFT	90HP @ 5800 RPM
INDUCTION SCAVENGING	SOHC
VALVES PER CYLINDER	4
(86 OCTANE) FUEL DELIVERY	PGM-FI VTEC
IGNITION SYSTEM	Microcomputer Programmed
STARTING SYSTEM	Electric
LUBRICATION	Wet Sump
COOLING SYSTEM	Water Cooled
ALTERNATOR	44 Amps
BATTERY CHARGING POWER	35 Amps
TRIM RANGE	- 4° to +16°
TILT RANGE	68°

DRIVE

GEAR RATIO	2.33:1 (12:28)
GEAR SHIFT	F-N-R
PROPELLER	Optional

DIMENSIONS

RECOMMENDED TRANSOM HEIGHT	(L) 508 mm/20 in. (X) 635 mm/25 in.
DRY WEIGHT	(L) 163 kg - 359 LBS.
DRY WEIGHT RC	(X) 169 kg - 373 LBS.

BF90

Features

Proven Technology **HR-V**

The technology we applied to our newest outboard engine is the very same that powers one of the most popular cars in the world.

A 4 Cylinder, 1496cc (91.4ci) engine, weighing in at only 163kg (359 lbs).
It's the lightest in its class.



VTEC synchronizes the lift and duration of the intake valves both at low rpm and at high rpm. This yields a longer, flatter torque curve which means **max power at every speed.**



A quick movement of the throttle control activates the **BLAST™** system, advancing the ignition curve aggressively.

"Holeshot" is vastly improved as more horsepower gets the **hull up on plane** quicker.



NMEA 2000® Certified

NMEA 2000 protocols allow engine data to be interfaced with on-board systems and systems displays, such as sonar and GPS.



Increases fuel efficiency by allowing combustion to operate on a leaner air/fuel mixture. At cruising speed, this engine runs on **20% less fuel*** than others in its class.



* Based on EPA Fuel Mode Consumption



Cast Iron Cylinder Sleeves

Ensures long term durability.

& Benefits



Programmed Electronic Fuel Injection

Delivers the precise amount of fuel/air to each cylinder. The result is **easy starts** and **instant throttle response** with superior fuel efficiency.

Variable Speed Trolling

Another great advantage for fishermen is the 90's push button troll speed. Simply push up or down in 50 RPM increments from 750 RPM to 1000 RPM. It's optional as a remote mounted toggle switch.

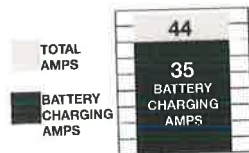

Honda

Superior Battery Charging

There's always plenty of electric power with Honda's exclusive neodymium magnet flywheel.

3 Position Tiller Handle

New 3-position tiller with toggle trolling control switch and toggle trim & tilt built into twist grip. (adapted from BF60)

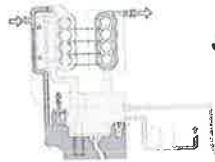

3 Way Cooling

Three separate cooling systems keep the cylinder head cooler for more long-term durability.

Corrosion Protection System

A patented "Double Sealed" multi-layered paint process. Sacrificial anodes and stainless steel technology, along with water resistant connectors, all enhance corrosion protection. Cooling passages are painted.

4FRONT
Corrosion Protection



High Performance Gearcase

Designed to get you going faster, this all new gearcase reduces drag, eliminates hull porpoise and minimizes spray, thus increasing **acceleration and top speed**.

HONDA MARINE

Distributor's Limited Warranty

Honda Outboard Motors

This warranty is limited to Honda Outboard Motors and related original equipment distributed by American Honda Motor Co., Inc., Power Sports and Products Division, 4900 Marconi Drive, Alpharetta, Georgia 30005-8847.

Products Covered by Warranty:	Length of Warranty: (from date of original retail purchase)		
	NON-COMMERCIAL/ NON-RENTAL	COMMERCIAL/ RENTAL	STATE/LOCAL/ FEDERAL GOVERNMENT
All models purchased on or after Jan. 1, 2016 ⁽²⁾	60 months	24 months	36 months
All models purchased between July 1, 2008 and December 31, 2015 ⁽²⁾	60 months	12 months	24 months
All models purchased on or before June 30, 2008 ⁽¹⁾⁽²⁾	36 months	12 months	24 months
Related original equipment items: BF5 through BF20 models: Portable fuel tank and original propeller, All models: Primer bulb/fuel line assembly and tiller handle.	The same duration as the outboard with which they were purchased. ⁽³⁾		

(1) Models purchased prior to July 1, 2008 (unless previously purchased with True-5 warranty from a participating dealer).

(2) 40, 65, & 105 Jet models: Jet pump assembly is a dealer installed option. Jet pump warranty is provided by Specialty Manufacturing Co. (Outboard Jets).

(3) Portable fuel tanks: 24 months or the same duration as the outboard they were purchased with, whichever is longer.

To Qualify for This Warranty:

The Honda Outboard Motor must be purchased from American Honda or a dealer authorized by American Honda to sell Honda Outboard Motors in the United States, Puerto Rico, or the U.S. Virgin Islands. This limited warranty applies to the first retail purchaser and each subsequent owner during the applicable warranty time period.

What American Honda Will Repair or Replace Under Warranty:

American Honda will repair or replace, at its option, any part that is proven to be defective in material or workmanship under normal use during the applicable warranty time period. Warranty repairs and replacements will be made without charge for parts or labor. Anything replaced under warranty becomes the property of American Honda Motor Co., Inc. All parts replaced under warranty will be considered as part of the original product and any warranty on those parts will expire coincidentally with the original product warranty.

To Obtain Warranty Service:

You must, at your expense, take your Honda Outboard Motor and proof of the original purchase date to any dealer who is authorized to service Honda Outboard Motors in the United States, Puerto Rico, or the U.S. Virgin Islands, during the dealer's normal business hours. If you are unable to obtain warranty service, or are dissatisfied with the warranty service you receive, take the following steps: First, contact the owner of the dealership involved; normally this should resolve the problem. However, if you should require further assistance, write or call the Honda Marine Customer Relations Department of American Honda Motor Co., Inc.

American Honda Motor Co., Inc.
Honda Marine Customer Relations Department
4900 Marconi Drive
Alpharetta, Georgia 30005-8847
Telephone: (770) 497-6400

Exclusions:

This warranty does not extend to the following:

- Conditions caused by lack of routine maintenance or improper storage (as outlined in the owner's manual)
- Conditions caused by the use of propeller(s) that do not allow the outboard motor to run in its recommended full throttle rpm range
- Operation inconsistent with the recommended operation/duty cycle (as outlined in the owner's manual)
- Parts affected or damaged by an abuse, submersion and/or collision
- Fuel contamination and water entering the engine through the fuel intake, air intake, or exhaust system
- Operation with fuels, oils, additives and lubricants which are not suitable for use in the product
- Use in an application for which the outboard motor was not designed, such as racing or competitive use or any other misuse or neglect
- Normal wear and tear
- Incorporation of unsuitable attachments or parts
- The unauthorized alteration, improper installation and/or rigging, or any causes other than defects in material or workmanship
- Corrosion to steering system or electrical components, corrosion due to electrolysis, water born foreign chemicals, improper service or corrosion caused by damage or abuse
- Reimbursement for towing charges, in and out of water charges, or technician travel time
- Growth of marine organisms on motor surfaces, external or internal
- Any product that has ever been declared a total loss or sold for salvage by a financial institution or insurer, or that has been issued a "salvage" or similar title under any state's law.

Disclaimer of consequential damage and limitation of implied warranties:

American Honda disclaims any responsibility for loss of time or use of the outboard, revenue, or the equipment in which the outboard is installed, transportation, commercial loss, or any other incidental or consequential damage. Any implied warranties are limited to the duration of this written limited warranty. Some states do not allow limitations on how long an implied warranty lasts and/or do not allow the exclusion or limitation of incidental or consequential damages, so the above exclusions and limitations may not apply to you. This warranty gives you specific legal rights, and you may also have other rights which vary from state to state.

American Honda Motor Co., Inc.

June 2023

Page 1 of 2

PWL504150.2023.06



Distributor's Limited Warranty

Accessories and Replacement Parts

This warranty is limited to Honda Marine parts, accessories and apparel when distributed by American Honda Motor Co., Inc., 4900 Marconi Drive, Alpharetta, Georgia 30005-8847.

Products Covered by Warranty:	Length of Warranty: (from date of original retail purchase)		
	NON-COMMERCIAL	COMMERCIAL/RENTAL	STATE/LOCAL/ FEDERAL GOVERNMENT
Accessories other than noted below	12 months	3 months	3 months
Emission related accessories; Portable fuel tanks, fuel line assemblies, and water/fuel separators	24 months	24 months	24 months
Replacement Parts	6 months	3 months	3 months

To Qualify for This Warranty:

- The accessories or replacement parts must be purchased from American Honda or a dealer, distributor, or distributor's dealer authorized by American Honda to sell those products in the United States, Puerto Rico, and the U.S. Virgin Islands. Parts and Accessories must be purchased for installation on original Honda equipment or engines to be eligible for warranty coverage. Installing Parts and Accessories on non-Honda products or engines voids this warranty.
- You must be the first retail purchaser. This warranty is not transferable to subsequent owners.

What American Honda Will Repair or Replace Under Warranty:

American Honda will repair or replace, at its option, any marine product accessories or replacement parts that are proven to be defective in material or workmanship under normal use during the applicable warranty time period. Anything replaced under warranty becomes the property of American Honda Motor Co., Inc. All parts replaced under warranty will be considered as part of the original product and any warranty on those parts will expire coincidentally with the original product warranty.

Accessories and replacement parts, installed by a dealer who is authorized by American Honda to sell them, will be repaired or replaced under warranty without charge for parts or labor. If installed by anyone else, accessories and replacement parts will be repaired or replaced under warranty without charge for parts, but any labor charges will be the responsibility of the purchaser.

To Obtain Warranty Service:

You must, at your expense, take the Honda Outboard Motor product accessory or replacement part or the outboard motor or boat on which the accessory or replacement part is installed, and proof of purchase to any Honda Marine authorized service facility or dealer in the United States, Puerto Rico, or the U.S. Virgin Islands, during normal business hours.

Exclusions:

This warranty does not extend to accessories or parts affected or damaged by collision, normal wear, use in an application for which the product was not designed or any other misuse, neglect, incorporation or use of unsuitable attachments or parts, unauthorized alteration, improper installation, or any causes other than defects in material or workmanship of the product. Installing parts and accessories on non-Honda products or engines voids this warranty.

Disclaimer of consequential damage and limitation of implied warranties:

American Honda disclaims any responsibility for loss of time or use of the outboard motor, or the boat on which the product is installed, transportation, commercial loss, or any other incidental or consequential damage. Any implied warranties are limited to the duration of this written warranty. Some states do not allow limitations on how long an implied warranty lasts and/or do not allow the exclusion or limitation of incidental or consequential damages, so the above exclusions and limitations may not apply to you.

This warranty gives you specific legal rights, and you may also have other rights, which vary from state to state.



EZ Loader Adjustable Trailer Limited Warranty

EZ Loader Boat Trailers, Inc. warrants each new Adjustable Boat Trailer to be free from defects in materials and workmanship for a period of three (3) years from the date of manufacture, or two (2) years from the date of first retail sale, whichever occurs first". EZ Loader shall repair or replace, without charge, any parts found to be defective because of imperfect workmanship or materials, within a reasonable time after the trailer is returned at purchaser's expense to any EZ Loader authorized distributor or dealer.

Who is Covered:

This warranty is extended to the original purchaser only and does not extend to any other persons to whom the trailer may be transferred.

What is Not Covered:

Provisions of this Warranty shall not apply to any product which is found to have been modified or altered in any way; nor shall the warranty apply to any defect or malfunction which was caused by damage, unreasonable use, or failure to provide reasonable and necessary maintenance. The warranty will not cover damage caused by overloading the trailer beyond stated capacities, improper adjustment of the trailer to the boat or the use of weight distribution hitches in conjunction with hydraulic surge brakes. Due to the highly corrosive conditions a trailer is exposed to, rust formation is not covered. The warranty does not cover winches, lights, couplers, actuators, brakes, tongue jacks, springs and tires or wheels, as these items are warranted separately by their manufacturer.

Other Limitations:

Races, bearings and seals are covered for 90 days from date of purchase. Any implied warranties, obligations, or liabilities, including but not limited to, any implied warranty of merchantability, shall be limited in duration to the two-year duration of this written limited warranty. Some states do not allow limitation on how long an implied warranty lasts, so the above limitation may not apply to you. The use of any unit as part of a rental fleet, or use for commercial purposes, voids this warranty.

The following are exclusions of EZ Loader Adjustables warranty:

Loss of time, inconvenience, towing charges, travel expenses, lodging, telephone, gas, loss or damages to personal property or loss of wages. This warranty is intended to comply with the "Magnusson Moss Warranty Federal Trade Commission Improvement Act" and any provisions of this warranty or actions taken by EZ Loader pursuant to this warranty shall be construed accordingly.

EZ Loader Boat Trailers, Inc., shall not be liable for any incidental or consequential damages for breach of this or any other warranty, express or implied. Some states do not allow the exclusion of limitation of incidental or consequential damages, so the above limitation or exclusion may not apply to you.

This warranty gives you specific legal rights, and you may also have other rights, which vary from state to state.

For more information, call 509-489-0181 or e-mail salesinfo@ezloader.com.

FOLLOWING ARE PHOTOS OF SAME BOAT WITH LESS OPTIONS AS REFERENCE



FOLLOWING ARE PHOTOS OF SAME BOAT WITH LESS OPTIONS AS REFERENCE

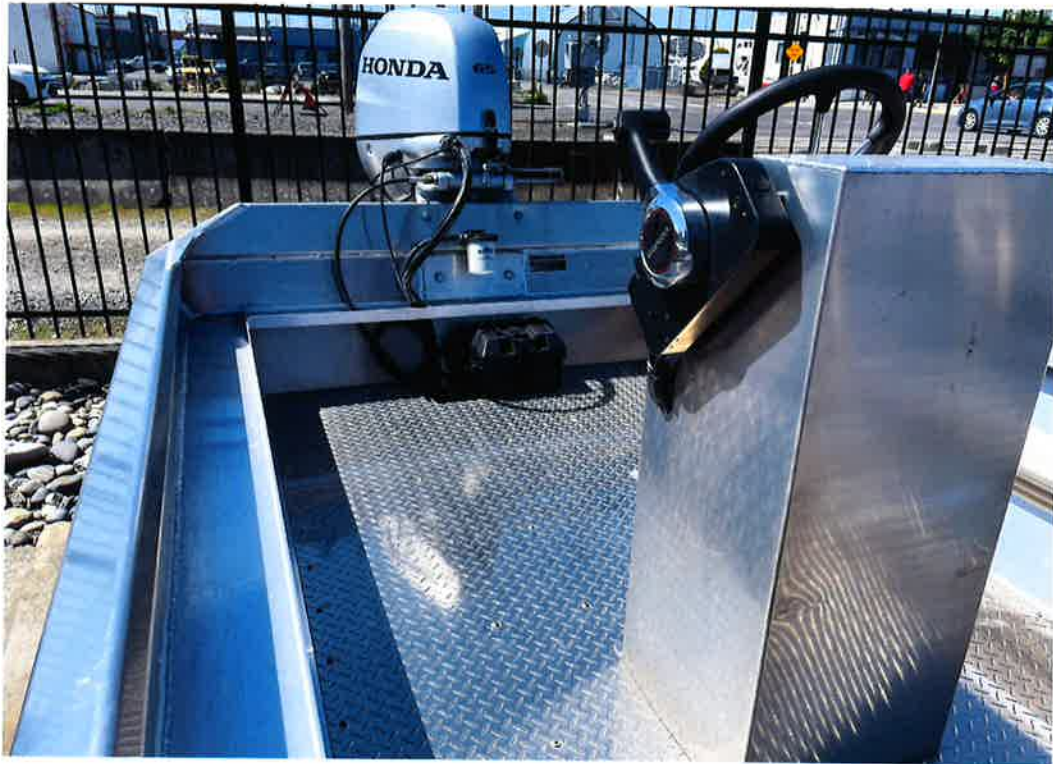

FOLLOWING ARE PHOTOS OF THE SAME BOAT WITH LESS OPTIONS AS REFERENCE

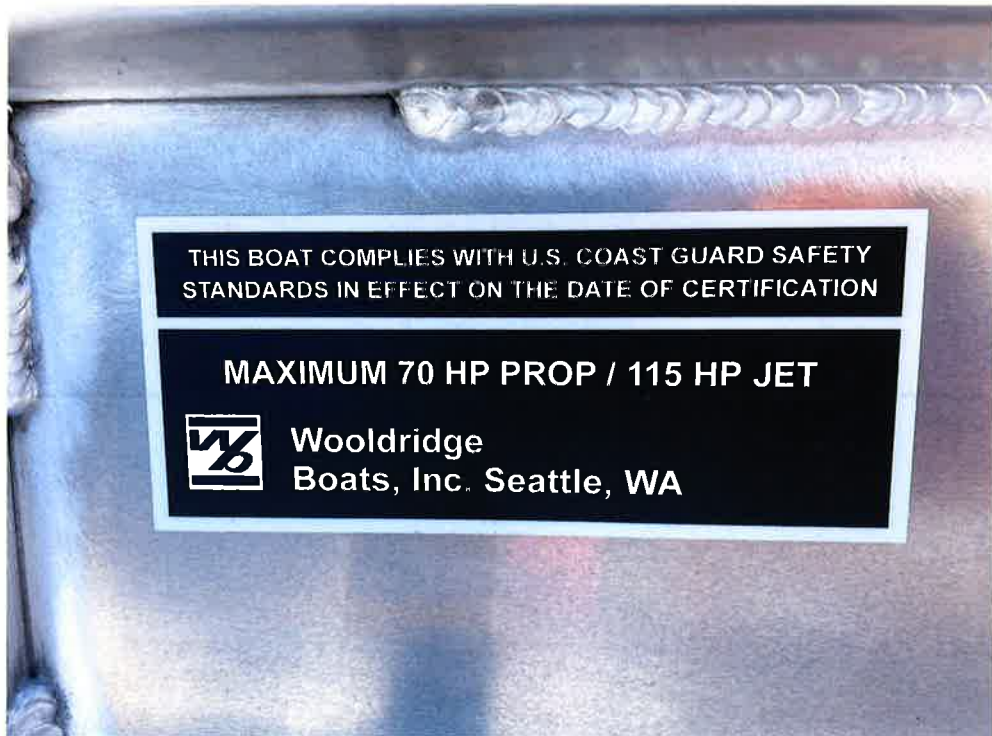
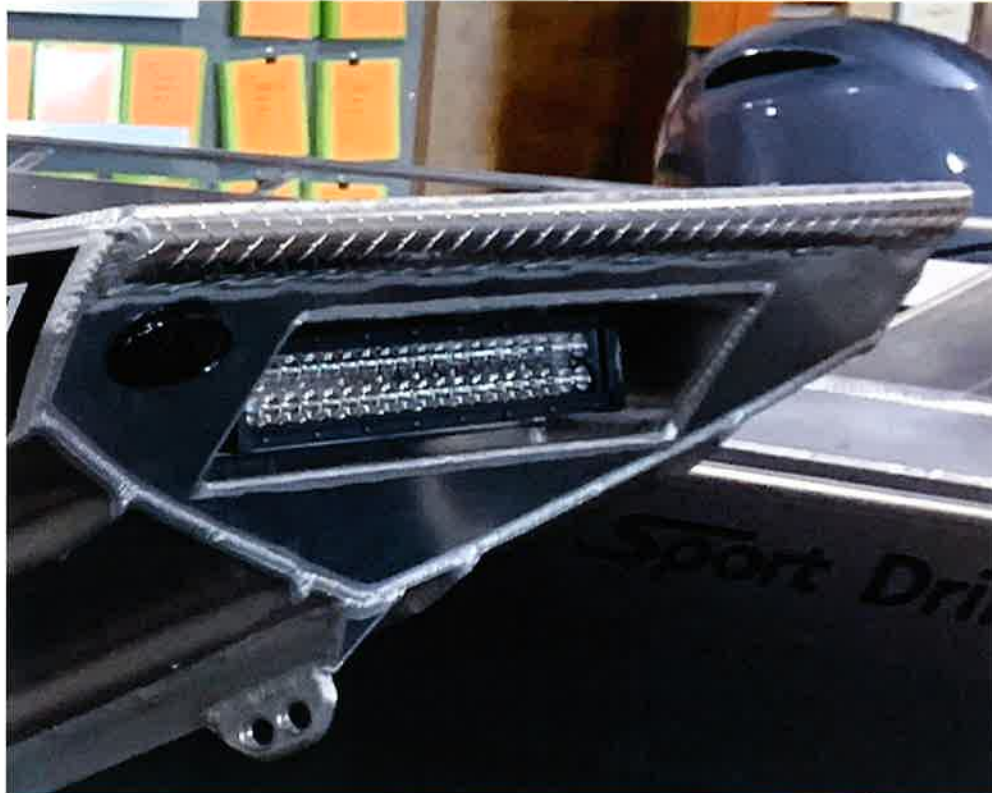

Bid #22-40 Prisoner Transport Unit

Bid Tabulation

	Technology International	West Coast Marine
BASIC BOAT		
Boats must be of sufficient size to handle a minimum crew of two, with the ability to carry up to four additional passengers, plus their equipment	YES	YES
Trailerable - Must include appropriately sized trailer configured for a conventional passenger tow vehicle	YES	YES
Boat must be equipped sufficiently to meet Coast Guard approval requirements	YES	YES
HULL		
Mono hull, 1/8" bottom and side gauge aluminum plate construction (Min.)	YES	YES
Length - 18-20' LOA (swin step or transom can add to length) <i>specify length</i>	22'	20"
Breadth - 7' BOA maximum <i>specify breadth</i>	91"	80"
Depth - proportional to length and beam <i>specify depth</i>	36"	21"
Welded center console with windshield and seat/storage in front of console	YES	YES
Grab rails on each side of windshield	YES	YES
Leaning post for driver with upholstered seat	YES	YES
Transom ladder	YES	YES
Easy access to all equipment that requires service and maintenance	YES	YES
Diamond plate floors	YES	YES
Welded bow eye and welded stern eyes	YES	YES
Sacrificial anode for salt/fresh water	YES	YES
Aluminum hand rails at bow and stern along gunnel	YES	YES
PROPULSION & CONTROLS		
One (1) four stroke Honda, Mercury, Suzuki or Yamaha outboard jet engine to match vessel; 65 rated HP minimum <i>specify make and model</i>	2023 Suzuki	Honda BF90/65 Jet
Fuel tank - 14 gallons (min.)	2 - 9 gallons	YES
RPM and hour display for engine data (min.)	YES	YES
ABYC Compliant electrical system	YES	YES
One (1) electric bilge pumps w/ auto/man/off switch	YES	YES
EPA compliant fuel and venting system	YES	YES
One (1) marine grade group 27 AGM start battery	YES	YES
NAVIGATION AND COMMUNICATION		
LED Navigation lights	YES	YES

Bid #22-40 Prisoner Transport Unit

Bid Tabulation

	Technology International	West Coast Marine
Navigation horn	YES	YES
OPERATIONAL EQUIPMENT		
LED headlight recessed in bow	YES	YES
One (1) fire extinguisher	YES	YES
Outfit kit including anchor w/ chain and rope, dock-lines, fenders, boat hook	YES	YES
PRESERVATION		
All dissimilar metals isolated from one another through best marine practices	YES	YES
WARRANTY (specify the minimum warranty on the following)		
Structural Hull	One (1) year	24 month
Motor	2023 115 HP Suzuki	36 month
Other (include description)		EZ load trailer 24 month
MISCELLANEOUS		
Three Complete sets of keys		Yes
One set of service manuals, including major overhaul of all components, electrical and hydraulic diagrams		Yes
One copy of Manufacturer's Statement of Retail Price (MSRP label) per unit		Yes
Price Each	108,500.00	48,117
Sales Tax	18,662.00	8,468.56
Total Bid	235,662.00	104,720.20

Whatcom County Budget Transfer Request

Department Sheriff's Office

Requested by Dawn Pierce

Source: (Accounts to transfer FROM)

<i>Cost Center Name</i>	<i>Cost Center - Account - Sub Account</i>	<i>Description</i>	<i>Amount</i>
SO Boat Program	1003502960 . 7060	Repairs & Maintenance	14,702.00
Total			14,702.00

Accounts to Increase:

<i>Cost Center Name</i>	<i>Cost Center - Account - Sub Account</i>	<i>Description</i>	<i>Amount</i>
SO Boat Program	1003502960 . 7410	Equip - Capital Outlays	14,702.00
Total			14,702.00

Purpose of Transfer: (If more room is necessary attach additional sheet.)

Temporary transfer of funds to provide adequate budget authority for purchase of two river and flood rescue boats. Purchase of the two boats was approved under ASR# 2023-6532 and \$90,000 was included in the 2023 budget. However, the apparent low bid (Bid #23-34) was \$104,702.20 and an additional \$14,702 is needed for the purchase. The attached Suppl ID# 4064 was submitted for the additional \$14,702 and is scheduled for Council vote in Sept. But, the Sheriff's Office needs to move forward with purchase of the rescue boats now. This budget transfer will be reversed once the supplemental budget is approved.

Authorizations:

Department Head *Buyer* Date 7.26.2024
 Executive's Office *[Signature]* Date 7-26-24
 Date Posted _____ By _____

*JK
AC/TK*