

**WHATCOM COUNTY CONTRACT
INFORMATION SHEET**

Whatcom County Contract No.
202304012

Originating Department:	Executive Office
Division/Program: (i.e. Dept. Division and Program)	Non-Departmental - Public Utility Improvement District -EDI
Contract or Grant Administrator:	Tawni Helms, Administrative Coordinator
Contractor's / Agency Name:	Whatcom County Drainage Improvement District 7

Is this a New Contract? If not, is this an Amendment or Renewal to an Existing Contract? Yes No
 Yes No If Amendment or Renewal, (per WCC 3.08.100 (a)) Original Contract #: _____

Does contract require Council Approval? Yes No If No, include WCC: _____
 Already approved? Council Approved Date: _____ (Exclusions see: Whatcom County Codes 3.06.010, 3.08.090 and 3.08.100)

Is this a grant agreement?
 Yes No If yes, grantor agency contract number(s): _____ CFDA#: _____

Is this contract grant funded?
 Yes No If yes, Whatcom County grant contract number(s): _____

Is this contract the result of a RFP or Bid process? Contract _____
 Yes No If yes, RFP and Bid number(s): _____ Cost Center: 332249

Is this agreement excluded from E-Verify? No Yes If no, include Attachment D Contractor Declaration form.

If YES, indicate exclusion(s) below:

<input type="checkbox"/> Professional services agreement for certified/licensed professional.	<input type="checkbox"/> Contract for Commercial off the shelf items (COTS).
<input checked="" type="checkbox"/> Contract work is for less than \$100,000.	<input type="checkbox"/> Work related subcontract less than \$25,000.
<input type="checkbox"/> Contract work is for less than 120 days.	<input type="checkbox"/> Public Works - Local Agency/Federally Funded FHWA.
<input type="checkbox"/> Interlocal Agreement (between Governments).	

Contract Amount:(sum of original contract amount and any prior amendments): \$ Grant: \$250,000 Loan: \$250,000 TOTAL: \$500,000 This Amendment Amount: \$ _____ Total Amended Amount: \$ _____	Council approval required for; all property leases, contracts or bid awards exceeding \$40,000 , and professional service contract amendments that have an increase greater than \$10,000 or 10% of contract amount, whichever is greater, except when : 1. Exercising an option contained in a contract previously approved by the council. 2. Contract is for design, construction, r-o-w acquisition, prof. services, or other capital costs approved by council in a capital budget appropriation ordinance. 3. Bid or award is for supplies. 4. Equipment is included in Exhibit "B" of the Budget Ordinance. 5. Contract is for manufacturer's technical support and hardware maintenance of electronic systems and/or technical support and software maintenance from the developer of proprietary software currently used by Whatcom County.
Summary of Scope: Whatcom County Drainage Improvement District 7 will receive funding in support of the Atwood Road Culvert replacement project in the amount of \$500,000 from EDI Funds.	

Summary of Scope:
 Whatcom County Drainage Improvement District 7 will receive funding in support of the Atwood Road Culvert replacement project in the amount of \$500,000 from EDI Funds.

Term of Contract:	Expiration Date: Upon completion
-------------------	----------------------------------

Contract Routing:	1. Prepared by: <u>Billie Sue Rinn/Tawni Helms</u>	Date: <u>05/22/2023</u>
	2. Attorney signoff: <u>Christopher Quinn</u>	Date: <u>05/31/23</u>
	3. AS Finance reviewed: <u>BBennett</u>	Date: <u>5/26/2023</u>
	4. IT reviewed (if IT related): _____	Date: _____
	5. Contractor signed: _____	Date: _____
	6. Submitted to Exec.: _____	Date: _____
	7. Council approved (if necessary): _____	Date: _____
	8. Executive signed: _____	Date: _____
	9. Original to Council: _____	Date: _____

**Economic Development Investment Program
Interlocal Loan & Grant Agreement**

I PARTIES

This Agreement is made by and between **Whatcom County** (hereinafter referred to as **the County**), and **Whatcom County Drainage Improvement District 7** (hereinafter referred to as **the District**).

II TERM

This Agreement takes effect upon execution hereof by the authorized representatives of both parties and continues in effect until all payments required under Section V, MUTUAL CONSIDERATION, Subsection C, REPAYMENT OF COUNTY LOAN, have been made or until terminated as provided for in Section VIII, TERMINATION.

III PURPOSE

The purpose of this Agreement is to provide funding support for the **Atwood Road Culvert Replacement Project** (hereinafter referred to as **the Project**) using certain County funds designated for such infrastructure development. These funds will be used to complete the Project as outlined in the Economic Development Investment (EDI) Program Application as attached (Attachment C).

IV RECITALS

The Parties make this Agreement based on and in recognition of certain relevant facts and circumstances including:

- A. Sales and use taxes are collected in and for the County under authority of RCW 82.14.370 and Whatcom County Code 2.130 for the purpose of financing public facilities in the County, and the proceeds are deposited in the Whatcom County Public Utilities Improvement Fund.
- B. The **District** will construct the Project. The Project will be partially funded by a **\$250,000 loan from the Whatcom County Public Utilities Improvement Fund, a \$250,000 grant from the Whatcom County Public Utilities Improvement Fund**, and the balance of the Project will be funded by the District with \$100,000 local match as outlined in Attachment C. The Project improvements, when complete, will be owned and maintained by **The District**.
- C. RCW 82.14.370 was adopted to serve the goals of promoting the ongoing

operation of business in rural distressed areas, promoting the expansion of existing businesses in rural distressed areas, attracting and developing new businesses, and providing family wage jobs and the development of communities of excellence in such areas. The parties expect the Project to further these goals.

D. RCW 82.14.370 defines public facilities to include bridges, roads, domestic and industrial water facilities, sanitary sewer facilities, earth stabilization, storm sewer facilities, railroad, electricity, natural gas, buildings, structures, telecommunications infrastructure, transportation infrastructure, or commercial infrastructure, and **The District** facilities in the state of Washington.

E. The County has created the EDI Board to review applications for loans and grants from the Public Utilities Improvement Fund and to make recommendations for Public Utilities Improvement Fund investments based on commitment of other funds, potential for resulting job creation, and other factors.

F. The EDI Board has reviewed the application for Public Utilities Improvement Funds and has recommended approval to the Whatcom County Council.

G. The County EDI Board has reviewed and recommended this project application be approved with a recommendation of a loan in the amount of \$250,000 and a grant in the amount of \$250,000, for a total of \$500,000. A copy of the EDI application for this project is attached by reference to this Agreement.

H. The Whatcom County Council reviewed the recommendation and approved a loan to the **District** from the Public Utilities Improvement Fund in the amount of \$250,000, and a grant to the **District** from the Public Utilities Improvement Fund in the amount of \$250,000.

I. The Public Utilities Improvement Fund balance is sufficient to make the requested loan and grant to the Project.

J. RCW 39.34 authorizes interlocal agreements whereby municipal governments may jointly exercise the powers granted to each.

V MUTUAL CONSIDERATION

The parties do not intend to create any new or separate legal or administrative entity by this Agreement but intend for this mutual Agreement to govern the County's financial support for the Project. The terms and conditions contained herein reflect the voluntary participation of the parties.

A. **The District RESPONSIBILITIES:** The **District** hereby agrees as follows:

- (i) If after the award of the construction contract, the scope of the Project or the Project budget has changed, the **District** shall provide the County the following updated documents: 1) a detailed description of the project; 2) a project budget itemizing major improvements together with the estimated cost of the improvements; and 3) a schedule showing sources and uses of

funding for the project, if any of the aforementioned documents varies from those that were submitted with the **District's** application for EDI funding.

- (ii) The **District** shall be responsible for all aspects of the design and construction of the project.
- (iii) The **District** shall be responsible for all aspects of the public works construction contract administration, which shall include, but not be limited to, advertising, bidding, and awarding the contract. The **District** will comply with all applicable laws, rules and regulations relating to bidding the project. The County shall have no responsibility for the Project other than the funding set forth herein.
- (iv) The **District** shall provide the County with a final report showing the actual cost of the project and the actual sources and uses of funding for the project.
- (v) The **District** shall repay the loan in full in accordance with the terms of Section V.C below and the amortization schedule set forth in Attachment A, attached hereto.

B. WHATCOM COUNTY'S RESPONSIBILITIES: The County hereby agrees as follows:

- (i) COUNTY LOAN—The County shall *loan* two hundred and fifty thousand dollars and zero cents (\$250,000.00) for the Project described herein (the "Loan"). This Loan shall be by County warrant drawn on the Public Utilities Improvement Fund and payable to the District, available upon written request after approval and execution of this agreement by the Whatcom County Council and the District, and pursuant to the terms contained in (iii) Payout of Loan and Grant Funding.
- (ii) COUNTY GRANT—The County shall issue a *grant* to the District for up to two hundred and fifty thousand dollars and zero cents (\$250,000.00) for the Project described herein. This grant shall be by County warrant drawn on the Public Utilities Improvement Fund and payable to the **District** upon approval of this agreement by the Whatcom County Council and the **District**, and pursuant to the terms contained in (iii), Payout of Loan and Grant Funding, below.
- (iii) PAYOUT OF LOAN AND GRANT FUNDING—The County shall pay out the loan and grant funding to the **District** up to a maximum of five hundred thousand dollars and zero cents (\$500,000.00) of the total project costs. This amount shall be paid in accordance with Attachment B, attached hereto. Disbursements of grant and loan funding shall be made contingent upon and subject to the continued commitment of the other project funding sources.
- (iv) Unless the parties to this agreement mutually agree in writing to modify the consideration, the funding identified herein is all the County is obligated to pay towards this project. The **District** agrees to protect the County from, hold it harmless from, and indemnify it for, any charges that may be levied in excess of the agreed amount.

C. **REPAYMENT OF COUNTY LOAN**—The District shall repay the Loan as follows:

- (i) The term of the Loan shall be **20** years, commencing from the date that the County disburses the Loan proceeds to the **District**. Interest shall accrue on the unpaid principal at a rate of 1% per annum. Interest shall begin accruing from the date of disbursement of loan funds.
- (ii) The **District** will make loan payments to the County annually on or before the anniversary date of receiving loan proceeds in accordance with the attached amortization schedule (Attachment A). Loan payments must be delivered to the Whatcom County Executive Department, Suite 108, 311 Grand Avenue, Bellingham, WA 98225.
- (iii) Failure to make the payment in the required amount by the date it is due according to the amortization schedule hereto attached shall constitute an event of default by the **District**. In the event that the **District** fails timely to make a Loan payment hereunder, the County shall notify the **District** of the failure and the **District** shall have fourteen (14) days to cure its failure. At the option of the County, such an event of default and the **District's** failure to cure within the stated time period is a sufficient basis upon which the County may take action to collect the amount that is delinquent, and if the County takes action to collect pursuant to this provision, the **District** shall pay to the County not only the amount owing, but also any collection of reasonable costs incurred by the County. Furthermore, if the **District** fails to make a payment on the Loan within thirty (30) days of the date it is due, and if the County has provided the **District** with the notice provided for in this section, then the County may choose to declare the remaining balance of the loan due and owing.
- (iv) There is no prepayment penalty should the **District** desire to retire this debt early, either in whole or in part.

VI RECORDS, REPORTS AND AUDITS

The **District** agrees to maintain such records, make such reports and follow such procedures pertaining to this Agreement as may be reasonably required by the County and as are typically maintained and made by the **District** in the undertaking of a project of this nature. All **District** records pertaining to this Agreement and the Project work shall be retained by the **District** for a period of three (3) years after final audit unless a longer period is required to resolve audit findings or litigation. The County and other authorized representatives of the State government shall have access to any books, documents, papers, and records of the **District** which pertain to this Agreement or the Project work for the purpose of making audit, examination, excerpts, and transcriptions.

VII RELATIONSHIP OF PARTIES AND AGENTS

Neither the **District** nor the County shall have authority to execute contracts or to make commitments on behalf of the other, and nothing contained herein shall be deemed to create the relationship of employer and employee or principal and agent

between the County and the **District**. This agreement does not create, either implicitly or explicitly, any right, duty or obligation that is not expressly provided for herein.

The **District** represents that it has or will secure at its own expense all personnel, contractors, and/or subcontractors required in order to perform the Project work. Such personnel shall not be employees of, or contractors with the County for purposes of the project described herein. All such personnel, contractors, and/or subcontractors shall be fully qualified (as determined by the **District** in its sole discretion) and authorized/permitted under State and/or local law to perform such services.

VIII TERMINATION

If the **District** fails to comply with the terms and conditions of this Agreement, the County may pursue such remedies as are legally available, including, but not limited to, the termination or closeout of this Agreement in the manner specified herein:

- A. **TERMINATION FOR CAUSE**— If the **District** fails to comply with the terms and conditions of this Agreement, the County will give notice to the **District** in writing of its failure to comply. The **District** will be given thirty (30) days from date of notice to comply with the terms of the Agreement or submit a plan acceptable to the County to bring the **District** into compliance with the Agreement within a time period reasonably acceptable to the County. Failure to comply with the terms and conditions of this Agreement by either party shall constitute an event of default. In the event of default by the **District** and a failure by the **District** to cure as provided for herein, the County may take such remedial actions under the law as are available to cure the default, including the imposition of the reasonable costs of collection. In the event of default by the County, the **District** may take such remedial actions under the law as are available to cure the default, including specific performance.
- B. **TERMINATION FOR OTHER GROUNDS**—This Agreement may be terminated in whole or in part by mutual consent and written agreement between the parties, duly authorized and executed, setting forth the conditions of termination, including effective date and, in case of termination in part, that Portion to be terminated.

IX COMPLIANCE WITH LAWS

The County and the **District** shall comply with all applicable laws, ordinances, and codes of the Federal, State and local governments with regard to the performance of this Agreement.

X INTEREST OF MEMBERS OF THE COUNTY AND THE DISTRICT

No member of the governing body of either party and no other officer, employee, or agent of either party who exercises any functions or responsibilities in connection

with the planning or carrying out of the Project shall have any personal financial interest, direct or indirect, in this Agreement.

XI HOLD HARMLESS AND INDEMNITY

To the extent permitted by law, the **District** shall indemnify and hold harmless the County, its officers, agents, and employees, from all liability, loss or damage, including costs of defense they may suffer as a result of claims, demands, actions, costs, or judgments which result from the activities to be performed by the **District**, its agents, employees, or subcontractors pursuant to this Agreement.

XII ASSIGNABILITY

The **District** shall not assign any interest in this Agreement and shall not transfer any interest in this Agreement (whether by assignment or novation) without prior written consent of the County thereto, provided, however, that claims for money by the **District** from the County under this Agreement may be assigned to a bank, trust company, or other financial institution without such approval. Written notice of any such assignment or transfer shall be furnished promptly to the County by the **District**.

XIII NON-WAIVER

The failure of either party to insist upon strict performance of any provision of this Agreement or to exercise any right based upon a breach thereof or the acceptance of any performance during such breach shall not constitute a waiver of any right under this Agreement.

XIV CONTRACT MODIFICATIONS

No modification or waiver of any clause or condition of this Agreement shall be binding upon either party unless such modification or waiver is in writing and duly authorized and executed by the County and the **District**.

XV SEVERABILITY

If any Portion of this Agreement is changed per mutual agreement or any Portion is held invalid, the remainder of this Agreement shall remain in full force and effect.

XVI NOTICES

Unless stated otherwise herein, all notices and demands shall be in writing and sent or hand-delivered to the parties to their addresses as follows:

TO THE DISTRICT: Tony Freeland
Whatcom County Drainage Improvement District 7
220 W. Champion St. #200
Bellingham, WA 98225

TO COUNTY: Brad Bennett, Finance Manager
c/o Whatcom County Executive's Office
311 Grand Avenue, Suite 108
Bellingham, WA 98225

or to such other addresses as the parties may hereafter designate in writing. Notices and/or demands shall be sent by registered or certified mail, postage prepaid, or hand-delivered. Such notices shall be deemed effective when mailed or hand-delivered at the addresses specified above.

XVII INTEGRATION

This Agreement contains all terms and conditions to which the County and the **District** agreed, and this Agreement supersedes all of their previous understandings and agreements, written and oral, with respect to this loan and grant transaction. There are no other oral or written agreements between the **District** and County as to the loan and grant terms contained herein. No changes or additions to this Agreement shall be valid or binding upon either party unless such change or addition be in writing, duly authorized and executed by both parties.

XVIII GOVERNING LAW AND VENUE

All questions of the validity, construction, and application of this Agreement shall be governed by the laws of the State of Washington. Venue for any suit between the parties arising out of this Agreement shall be the Superior Court of the State of Washington in and for Skagit County, Washington.

XIX RECORDING

Upon execution of this agreement by the parties hereto, the County shall cause it to be posted on the county web site, or otherwise published pursuant to the requirement contained within RCW 39.34.040.

IN WITNESS WHEREOF, the County and the **District** have executed this Agreement as of the date and year last written below.

EXECUTED, this _____ day of _____, 2023, for the **Whatcom County Drainage Improvement District 7:**

Kevin Maddox, District Supervisor

STATE OF WASHINGTON)
) ss.
COUNTY OF Whatcom)

On this _____ day of _____, 2023, before me personally appeared **Kevin Maddox**, to me known to be the **District Supervisor** of the **Whatcom County Drainage Improvement District 7** and who executed the above instrument and who acknowledged to me the act of signing and sealing thereof.

NOTARY PUBLIC in and for the State of Washington,
residing at _____.
My commission expires _____.

EXECUTED, this _____ day of _____, 2023, for **WHATCOM COUNTY:**

Approved as to form:

Christopher Quinn per email 05/31/23

Chief Civil Deputy Prosecutor Date

Approved: Accepted for Whatcom County:

Satpal Sidhu, Whatcom County Executive

STATE OF WASHINGTON)
) ss
COUNTY OF WHATCOM)

On this _____ day of _____, 2023, before me personally
appeared **SATPAL SIDHU**, to me known to be the **COUNTY EXECUTIVE** of
Whatcom County, who executed the above instrument and who acknowledged to me
the act of signing and sealing thereof.

NOTARY PUBLIC in and for the State of Washington,
residing at _____.
My commission expires _____.

Attachment A

Amortization Schedule

WHATCOM COUNTY						
EDI Loan Whatcom County Drainage Improvement District #7						
		Principal			\$250,000	
		Interest Rate			1.00%	
		Term (years)			20	
#	Year	Beginning Balance	Payment	Interest	Principal	Ending Balance
1	2024	\$250,000	(\$13,854)	2,500	(\$11,354)	\$238,646
2	2025	\$238,646	(\$13,854)	2,386	(\$11,468)	\$227,178
3	2026	\$227,178	(\$13,854)	2,272	(\$11,582)	\$215,597
4	2027	\$215,597	(\$13,854)	2,156	(\$11,698)	\$203,899
5	2028	\$203,899	(\$13,854)	2,039	(\$11,815)	\$192,084
6	2029	\$192,084	(\$13,854)	1,921	(\$11,933)	\$180,151
7	2030	\$180,151	(\$13,854)	1,802	(\$12,052)	\$168,099
8	2031	\$168,099	(\$13,854)	1,681	(\$12,173)	\$155,926
9	2032	\$155,926	(\$13,854)	1,559	(\$12,295)	\$143,632
10	2033	\$143,632	(\$13,854)	1,436	(\$12,418)	\$131,214
11	2034	\$131,214	(\$13,854)	1,312	(\$12,542)	\$118,672
12	2035	\$118,672	(\$13,854)	1,187	(\$12,667)	\$106,005
13	2036	\$106,005	(\$13,854)	1,060	(\$12,794)	\$93,211
14	2037	\$93,211	(\$13,854)	932	(\$12,922)	\$80,289
15	2038	\$80,289	(\$13,854)	803	(\$13,051)	\$67,239
16	2039	\$67,239	(\$13,854)	672	(\$13,182)	\$54,057
17	2040	\$54,057	(\$13,854)	541	(\$13,313)	\$40,744
18	2041	\$40,744	(\$13,854)	407	(\$13,447)	\$27,297
19	2042	\$27,297	(\$13,854)	273	(\$13,581)	\$13,716
20	2043	\$13,716	(\$13,853)	137	(\$13,716)	\$0

Attachment B

Whatcom County Drainage Improvement District 7 – Atwood Road Culvert Replacement Project Loan and Grant Draw Down Requirements

The \$250,000.00 grant funding will be disbursed prior to any loan funding, as follows:

The **District** will send invoices for project expenses to Whatcom County Executive's Office, 311 Grand Avenue, Suite 108, Bellingham, WA 98225. Invoices will include copies of receipts. Funds will be made available by warrant within 30 days following receipt of invoice and are for reimbursement of project expenses only. The request for grant funds should reference the Whatcom County assigned interlocal agreement number.

The \$250,000.00 loan will be disbursed as follows:

Following the disbursement of all grant funds, the loan funds will be made available for application to the project by warrant within 30 days of receipt of written request from **the Supervisor** of the **District**, and sent to the Whatcom County Executive's office, 311 Grand Avenue, Suite 108, Bellingham, WA 98225. The request will include the full loan amount (\$250,000.00), and a reference to the contract number assigned to this Interlocal Agreement. Repayment of the loan will begin one year from the disbursement date and follow the schedule noted in Attachment A.

RECEIVED

OCT 19 2022

**Whatcom County
Economic Development
Investments Program**

**WHATCOM COUNTY
EXECUTIVE'S OFFICE**

Application for Funding



Satpal Sidhu, Whatcom County Executive

Whatcom County Economic Development Investment (EDI) Program
Revolving Loan and Grant Program to Encourage Creation or Retention of Private Sector Jobs

Preliminary Information and Application

Note: The intent of this Program is to be consistent with State law, RCW 82.14.370

- 1. Who is eligible to apply:** Local general or special-purpose governments and higher education.
- 2. What projects are covered:** Construction of publically-owned infrastructure, facilities, and related improvements, which enable or encourage the creation or retention of private sector businesses and jobs in Whatcom County consistent with EDI Program Policy Objectives.
- 3. What activities are fundable:** New construction, refurbishment, replacement, rehabilitation, renovation or repair. Demolition is allowable if tied to construction. Soft costs allowed within scope of construction budget. No land acquisition except right-of-way included in a construction project.
- 4. What can you use the funds for:** Transportation (roads, bridges, rail), utility services (water, sewer, storm, energy, telecom) and public buildings or structures.
- 5. Other Limitations:** Planning/feasibility only projects are not eligible. Minimum local match is 10% of EDI request. EDI Board will make recommendations to the County Council which makes the final decision.

Preferential Project Types

First Preference – “JOBS IN HAND PROJECTS” – These types of projects will allow for the immediate creation and/or retention of jobs by providing public infrastructure that directly supports jobs. A perfect example would be a private business that will build or move into a facility and hire employees if a road is built or if water/sewer lines are extended to the site. These types of proposals would include a commitment by the private sector employer to create jobs and provide private investment.

Second Preference – “BUILD IT AND JOBS WILL COME PROJECTS” – These types of projects will construct public infrastructure but are not associated with a specific commitment from a private business to locate and/or create jobs. A perfect example would be the construction of roads and utility infrastructure to serve a new business park that would benefit multiple businesses.

Third Preference – COMMUNITY ENHANCEMENT PROJECTS” – These types of projects generally improve the physical appearance or create community assets to enhance the business climate. Examples would be boardwalk, streetscaping, downtown structures, and other publicly-owned facilities that make a community or region more attractive to existing or future businesses.

Whatcom County Economic Development Investment (EDI) Program
Revolving Loan and Grant Program to Encourage Creation or Retention of Private Sector Jobs

Preferential Project Terms

First Preference – EDI LOAN – Due to the preferred revolving nature of EDI funds, proposals that are loan only will receive higher scoring. Loan terms and interest rate structure matches the Public Works Trust Fund program. The county will maintain discretion to modify such as including a deferral period.

Second Preference – LOAN/GRANT COMBINATION – The preferred combination of grant funds and loan funds is 1/3 grant, 2/3 loan.

Third Preference – EDI GRANT – Due to the “one-shot” nature of grants, projects of equal scoring requesting a grant only will be scored lower than another similar project requesting a loan/grant mix.

Preferential* Project Amounts (Guidelines)

JOBS IN HAND PROJECTS - \$1,000,000 limit if grant only. \$2,000,000 limit if combination of grant and loan. \$3,000,000 limit if loan only.

BUILD IT AND JOBS WILL COME PROJECTS - \$500,000 limit if grant only. \$1,000,000 limit if combination of grant and loan. \$1,500,000 limit if loan only.

COMMUNITY ENHANCEMENT PROJECTS - \$250,000 limit if grant only. \$500,000 limit if combination of grant and loan. \$750,000 limit if loan only.

*Based on compelling reasons, the EDI Board and County Council may consider exceptions.

Whatcom County Economic Development Investment (EDI) Program
Revolving Loan and Grant Program to Encourage Creation or Retention of Private Sector Jobs

FILLABLE FORM BEGINS HERE

Past Performance

Have you received EDI Program funding in the past? _____; Yes No

If yes, provide project name and EDI grant/loan awarded: N/A

If yes, EDI Program staff and/or the EDI Board may conduct an audit to review performance measures against projected outcomes, such as job creation projections.

Has your jurisdiction received any audit findings from the Washington State Auditor in the past 10 years?
_____ Yes; No. If yes, provide details:

N/A

Whatcom County Economic Development Investment (EDI) Program
Revolving Loan and Grant Program to Encourage Creation or Retention of Private Sector Jobs

THRESHOLD PROJECT CRITERIA

Evidence of Planning

YES	NO	
<input checked="" type="checkbox"/>	<input type="checkbox"/>	Project included on an adopted regional economic strategy (“CEDS” list).
<input checked="" type="checkbox"/>	<input type="checkbox"/>	Project included in the applicant’s Comprehensive Plan.
<input checked="" type="checkbox"/>	<input type="checkbox"/>	Project included in the applicant’s Capital Expenditure Plan or adopted budget.

COMMENTS:

We have confirmed this project location is on the Whatcom County 2022-2026 CEDS list. This project is also included in our comprehensive multi-phase plan and is included in our adopted budget.

THRESHOLD PROJECT SCORING

POINTS

Preferential Project Type

<u>10</u>	<input checked="" type="checkbox"/> Jobs In Hand	<i>10 points</i>
	<input type="checkbox"/> Build It And Jobs Will Come	<i>5 points</i>
	<input type="checkbox"/> Community Enhancement	<i>2 points</i>

5 Preferential Project Terms

<input type="checkbox"/> Loan Only	<i>10 points</i>
<input checked="" type="checkbox"/> Loan/Grant	<i>5 points</i>
<input type="checkbox"/> Grant Only	<i>2 points</i>

5 Preferential Project Amounts

<input checked="" type="checkbox"/> Within Dollar Limits	<i>5 points</i>
<input type="checkbox"/> Outside Preferred Dollar Limits	<i>0 points</i>

20
TOTAL POINTS

To proceed to other parts of the application and to receive EDI Board review, a proposed project must score 10 or more points on the above section.

Our project meets multiple project types.

Whatcom County Economic Development Investment (EDI) Program
Revolving Loan and Grant Program to Encourage Creation or Retention of Private Sector Jobs

PROJECT APPLICANT

Applicant Name: Whatcom County Drainage Improvement District 7
Applicant Address: 220 W. Champion St. #200 Bellingham, WA 98225
Applicant Contact Person: Tony Freeland
Applicant Email and Phone Number: Phone: (360) 650-1408 Email: tfreeland@freelandengineering.com

PROJECT TITLE

Atwood Road Culvert Replacement

PROJECT AMOUNT REQUESTED

\$ 600,000.00 EDI TOTAL - (Loan \$ 300,000.00 ; Grant \$ 200,000.00)
\$ 100,000 (16.6%) Local Match (10% of EDI request minimum)

PROJECT TYPE

Jobs In Hand Build It And Jobs Will Come Community Enhancement

PROJECT TERMS

Loan Only Grant/Loan Grant Only If a loan, term requested: 30 (years)

PROJECT LOCATION: 7084 Atwood Road

Whatcom County Economic Development Investment (EDI) Program
Revolving Loan and Grant Program to Encourage Creation or Retention of Private Sector Jobs

PROJECT DESCRIPTION
(one page limit)

The founding primary purpose for DID #7 was to increase the farm-ability of agricultural lands within its boundary.

To accomplish its responsibilities DID #7 has authority to levy acreage taxes on all properties within its boundary. The current acreage only assessment rate generates about \$20,000 annually on a per acre basis. DID 7 Supervisors have approved a tax assessment method to increase funds that will allow us to generate more money for permitting, box culverts, channel dredging, beaver trapping, beaver dam removal and mitigation and enhancement for any disturbance of aquatic habitat in fish bearing waters. Also to include budgeted funds for loan and interest payments.

Many properties in the district have been converted from agriculture to urban/residential, commercial, and light industrial. This conversion requires a much different drainage scenario than agriculture lands. Because of the inadequate drainage these properties experience periodic damaging flooding from overflowing ditches, rain, and melt. This poor drainage is also hindering future development and job creation by making the land undesirable for businesses to purchase this land and bring jobs to this area. This project would enhance the business climate by making the industrial parks and community a more desirable place to invest in.

The city of Ferndale has annexed properties within the DID for urban, commercial and industrial growth. The I-5 light Industry area east of I-5, the Grandview and Delta Circle industrial parks west of I-5, the proposed Love's truck stop property, Ferndale urban, Northgate business park developments all are at the head waters of DID #7 and are expected to add considerable more rapid flow into the lower areas and into an already inadequate drainage system.

We have broken the immediate needs of DID #7 into phases. All phases have the same goal to create a better drainage outlet for business and community enhancement with an overarching goal of creating more jobs. This will be done by replacing an undersized culvert, easement relocation, stream realignment and dredging.

PHASE ONE: Increasing the size of the Atwood culvert will encourage community vitality by improving the drainage for industrial business land that will result in more jobs in the area. This will also keep the local residential land and homes free from flood water. Currently the Atwood culvert and streams flood every year, causing damage and polluted runoff to inundate local property.

PHASE TWO: Currently part of the ditch is not located on the county easement, it encroaches in private residential land. The current owner is willing to work with us to grant a new easement to rechannel the ditch away from buildings and inundated areas. This will eliminate the need for expensive litigation over the current location of the ditch.

PHASE THREE: Without addressing these needs existing and future developments will continue to be hampered by poor drainage and new business developments will not be able to use designated lands for their purposes. This will hamper the economic development of the areas.

Whatcom County Economic Development Investment (EDI) Program
Revolving Loan and Grant Program to Encourage Creation or Retention of Private Sector Jobs

BASIC PROJECT INFORMATION

1. Complete the public project budget and status of funds below. If EDI funds are approved is funding 100% complete? Yes No

Please explain:

We have detailed estimates and feel very comfortable completing this project with the amount of funding we are requesting.

<u>Funding Source</u>	<u>Amount</u>	<u>Planned/Applied For</u>		<u>Secured</u>	
Federal Dollars	\$ 0	Yes <input type="checkbox"/>	No <input checked="" type="checkbox"/>	Yes <input type="checkbox"/>	No <input checked="" type="checkbox"/>
State Dollars	\$ 0	Yes <input type="checkbox"/>	No <input checked="" type="checkbox"/>	Yes <input type="checkbox"/>	No <input checked="" type="checkbox"/>
Local Dollars	1 100,000.00	Yes <input checked="" type="checkbox"/>	No <input type="checkbox"/>	Yes <input checked="" type="checkbox"/>	No <input type="checkbox"/>
EDI Funding	\$ 500,000.00	Yes <input checked="" type="checkbox"/>	No <input type="checkbox"/>	Yes <input type="checkbox"/>	No <input checked="" type="checkbox"/>
TOTAL	<u>\$ 600,000.00</u>				

2. Describe the amount of outside (private) funding committed to the project (eg. Plant and equipment).

I-5 Industrial Park Association is committed to providing \$100,000.00

3. Describe the public infrastructure being proposed. Include engineering estimates and a site map detailing the proposed improvements as Attachments A and B. _____

Pre-cast concrete culvert. See attachment for estimates and site map

4. Describe how these improvements will enhance or encourage community vitality and stimulate other private development in the area.

50 year plan was never intended to be what it is now. The local growth rate plan is not supported with such a small culvert. Increasing the size of the culvert and eventually rerouting the stream will encourage community vitality by keeping the local residential land and homes free from flood water. Currently the Atwood culvert and streams flood every year, causing damage and polluted runoff to inundate local residential and industrial property. Please refer to the current Ferndale growth plan to see the rate of growth is not supported by the undersized existing infrastructure.

Whatcom County Economic Development Investment (EDI) Program

Revolving Loan and Grant Program to Encourage Creation or Retention of Private Sector Jobs

5. List all permits and environmental reviews required for the public project and detail their status (completed, in-process, etc.)

	In Process	Date Completed
Preliminary Engineering	_____	2022 _____
Environmental Review	_____	2022 _____
Design Engineering	_____	2022 _____
Right-of-Way	_____	2022 _____
Construction Permits	2023 _____	_____
Environmental Permits	2023 _____	_____
Bid Documents	2023 _____	_____
Award Construction Contract	2023 _____	_____
Begin Construction	2023 _____	_____
Project Operational	2023 _____	_____
_____	_____	_____

6. Are any other public jurisdictions involved in this project? If so, in what way?

Washington Department of Fish and Wildlife - HPA Permit
 Whatcom County Planning - Land Disturbance Permit
 Nooksack Salmon Enhancement Association - Mitigation

7. Who will maintain the public facility/infrastructure to be completed with EDI funds? Will this project impact utility rates within the jurisdiction?

Whatcom County Drainage Improvement District 7 will maintain the culvert. Annual assessments will be amended to fund the debt service on the loan and maintenance costs.

8. Will this project directly generate a revenue stream that could be used to repay an EDI loan? Will this project spur indirect revenues that could be used to repay an EDI loan? If no to either question – why?

Yes, currently changing tax assessment matrix to increase tax pool, Project will improve property for future businesses to develop land witch will increase the tax assessment pool. New tax assessment matrix available upon request.

Whatcom County Economic Development Investment (EDI) Program

Revolving Loan and Grant Program to Encourage Creation or Retention of Private Sector Jobs

9. What other revenue sources are available for this project and have they been considered. This includes forming a Local Improvement District (LID or ULID), issuing Councilmatic Bonds, Revenue Bonds, or other source(s).

Whatcom County Drainage Improvement District No. 7 is not eligible for these funding programs..

10. Describe the private development project that will be supported by this public facility project. If there is a committed private sector partner include Contingency Agreement (Attachment C).

I5 Industrial Center is an existing light industry business park that requires these improvements. The park's association has committed to \$100,000 in matching funds and agreed to an increase in tax assessments to cover the loan's debt service and associated maintenance.

11. Explain why the private development requires the proposed public improvement(s).

I5 Industrial Center is an existing light industry business park that has all infrastructure in place to construct buildings for commercial and industrial use. The drainage improvements are needed to address frequent flooding that occurs on properties in the park.

12. What is the status of the associated private development review and permits. List all permits required and give the current status (applied for, being reviewed, issued).

	In Process	Date Completed
Environmental Review	<u>X</u>	_____
Construction Permits	<u>X</u>	_____
Environmental Permits	<u>X</u>	_____
_____	_____	_____

Whatcom County Economic Development Investment (EDI) Program

Revolving Loan and Grant Program to Encourage Creation or Retention of Private Sector Jobs

13. Describe the type of industry or economic activity the public development will attract. What is the strategy to attract industry to the project site?

Light Industrial and manufacturing is the type of economic development this project will attract which will add to the rapid development within the seven existing surrounding industrial parks.

14. List the number of projected jobs, by type, to be retained and/or created by the private entity.

Occupation	Current Jobs Retained** (In FTEs)	# Of Jobs Created Year 1 (In FTEs)	# Of Jobs Created by Year 5 (In FTEs)	Hourly Wage of current or new position	Local Occupational Hourly Wages***
Mgmt./Admin*	12	2	10	\$80	N/A
Technical/Prof	3	1	5	\$70	
Office/Clerical	15	1	5	\$40	
Production	8	2	5	\$45	
Sales	3	4	5	\$50	
Skilled Crafts	280	2	70	\$68	
Others					
Totals	321	12	100	N/A	N/A

* Indicate Management positions in annual salary.

** Retained jobs are defined as jobs that would otherwise be lost from the county without this project.

*** This column will be populated with data from the state before application is distributed and revised annually.

- a. Projected annual gross payroll for all job classifications \$ 44,345,600 current \$58,042,400 projected
- b. Describe fringe benefits the company offers to regular full time employees?
(health insurance, retirement plans, etc.) Health insurance and retirement benefits of \$10,508,816 is provided.

Whatcom County Economic Development Investment (EDI) Program

Revolving Loan and Grant Program to Encourage Creation or Retention of Private Sector Jobs

15. How does this project support the economy of Whatcom County and how does it fit into a county-wide

Economic development strategy is to strengthen and sustain the regional economy. Its intent is to bring together the public and private sectors in the creation of an "economic roadmap" to diversify and strengthen the regional economy by integrating the Region's human resources and its capital-improvements planning in the service of economic development. This project will do just that, bring the private and public sectors together.

~~16. What will the effect of this project be on the natural environment – does the project address any issues related to public health, pollution, or quality of life?~~

This project will only improve the natural surrounding environment, public health and quality of life. yearly this area is inundated with water from under sized culverts and ditches. Well water will be improved and water will stop inundating the septic drainage fields causing public health concerns from sewerage, roadway and parking lot runoff.

17. Does this project address any existing issues related to public safety and/or does it increase public safety in the future or address a potential future public safety issue?

Currently flooding water comes over the roadway creating safety issues. This project would address and fix this issue.

18. Describe specific quantifiable measures of the outcomes, other than purely jobs, that will demonstrate project success. Describe how you will measure this and explain what you expect to show as progress toward the outcome.

The outcomes of this project will be quantifiable and visually obvious. This project will increase the ability to develop commercial property that would provide family wage jobs, create drainage capacity for future industrial zones, increase quality of stream habitat stream habitat for salmon and other wildlife, increase water flow, control local flooding, alleviate the seeping sewage from drainage fields.

Application for Funding – Certification

I HEREBY CERTIFY THAT THE INFORMATION GIVEN IN THIS APPLICATION TO WHATCOM COUNTY FOR INVESTMENTS IN ECONOMIC DEVELOPMENT IS TRUE AND CORRECT TO THE BEST OF MY KNOWLEDGE AND BELIEF.

Signature of Responsible Public Official:



Date 10-18-12

RECORD OF SURVEY

BEING A PORTION OF THE SOUTHWEST 1/4 OF THE NORTHEAST 1/4 OF SECTION 6, TOWNSHIP 39 NORTH, RANGE 2 EAST OF W.M. WHATCOM COUNTY, WASHINGTON

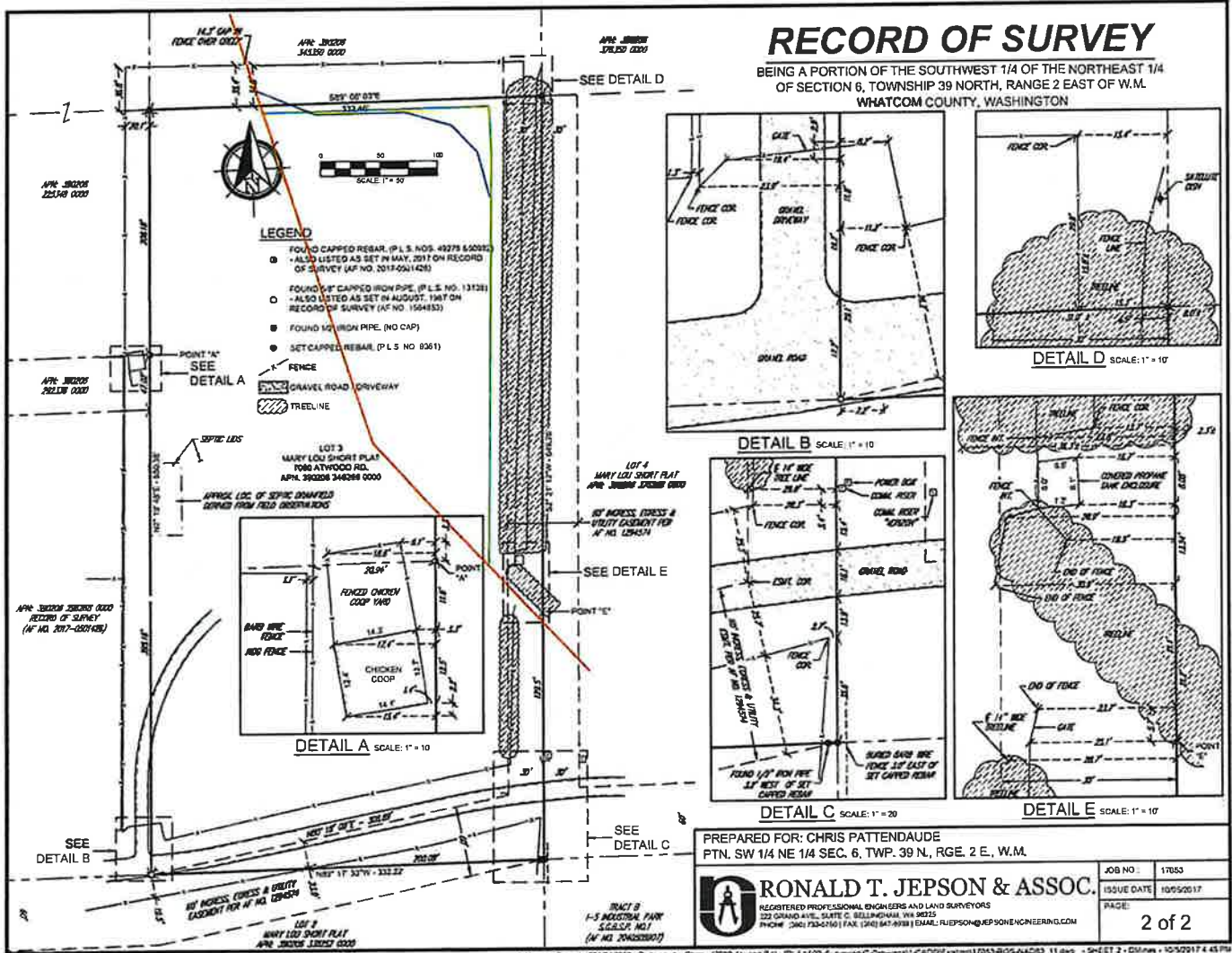

PREPARED FOR: CHRIS PATTENDAUE
PTN. SW 1/4 NE 1/4 SEC. 6, TWP. 39 N., RGE. 2 E., W.M.

RONALD T. JEPSON & ASSOC.
REGISTERED PROFESSIONAL ENGINEERS AND LAND SURVEYORS
122 GRAND AVE., SUITE C, BELLINGHAM, WA 98225
PHONE: (360) 733-0160 | FAX: (360) 841-8938 | EMAIL: RJEPSON@RJPSONENGINEERING.COM

JOB NO:	17853
ISSUE DATE:	10/05/2017
PAGE:	2 of 2

L:\Jepson Projects\2017\17853 - Pattendaue, Chris - (7300 Amscot Rd) - [BLA]00-Surveying-C-09-ngr11-CAD02-10/05/17053-ROS-AA-CAD_11.dwg - SHEET 2 - 05/10/17 4:43 PM





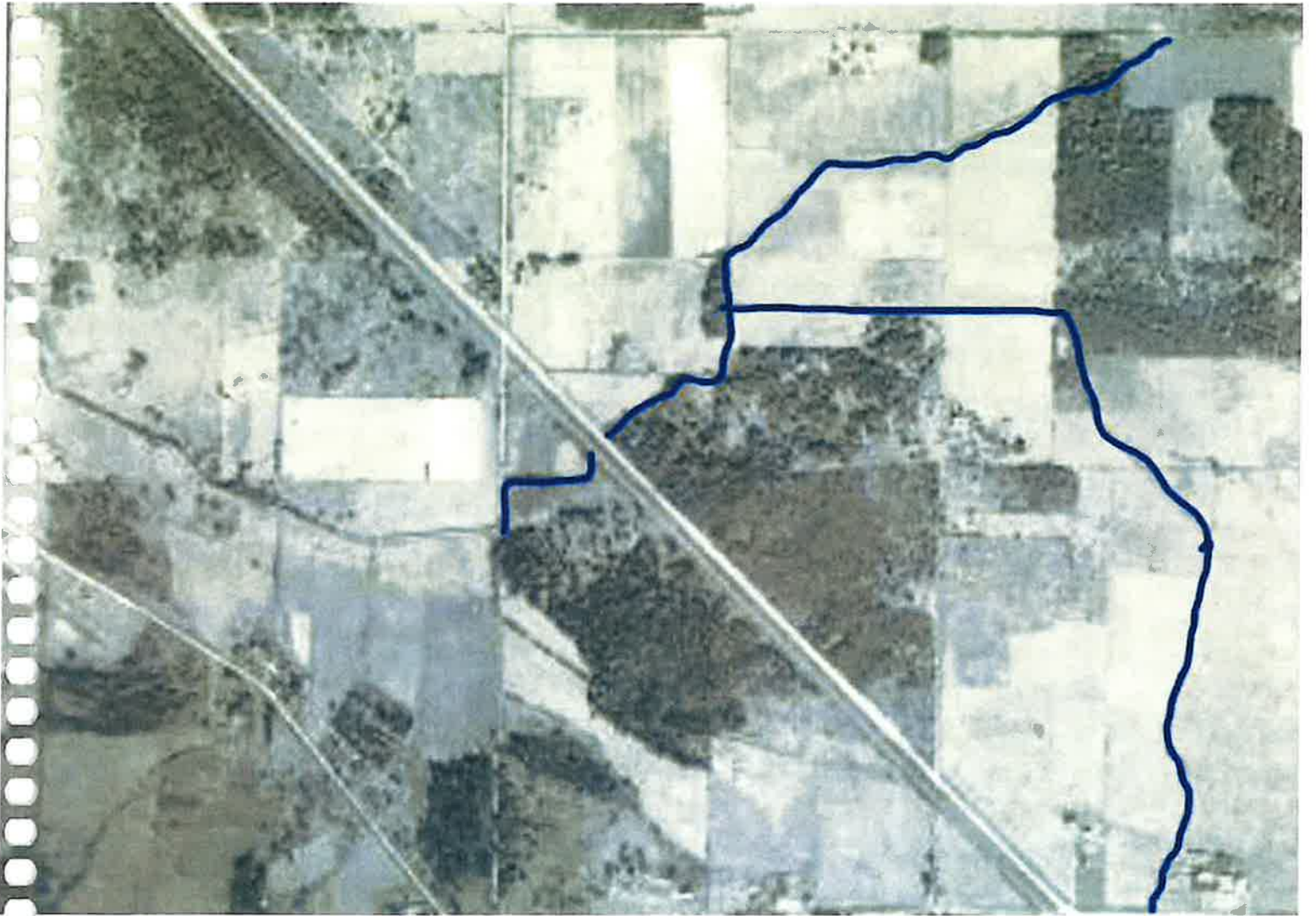



Freeland and Associates, Inc.

220 W. Champion St., Suite 200
Bellingham, Washington
(360) 650-1408

**Atwood Road Culvert Replacement
Engineer's Estimate**

Construction

1. Mobilization	\$55,000
2. Erosion Control	\$5,000
3. Clearing	\$15,000
4. Stream Realignment	\$15,000
5. Culvert	\$380,000
	<hr/>
<i>Subtotal</i>	\$470,000
<i>WSST (8.8%)</i>	\$41,360
Total Construction	<hr/> \$511,360

Engineering

1. Surveying	\$5,000
2. Engineering	\$35,000
3. Critical Area Report	\$15,000
	<hr/>
Total Engineering	\$55,000

Permitting

1. WSWF HPA	\$15,000
2. Whatcom County Land Disturbance Permit	\$15,000
	<hr/>
Total Permitting	\$30,000

Total Project \$600,000

MAP 1, FERNDALE URBAN GROWTH AREA

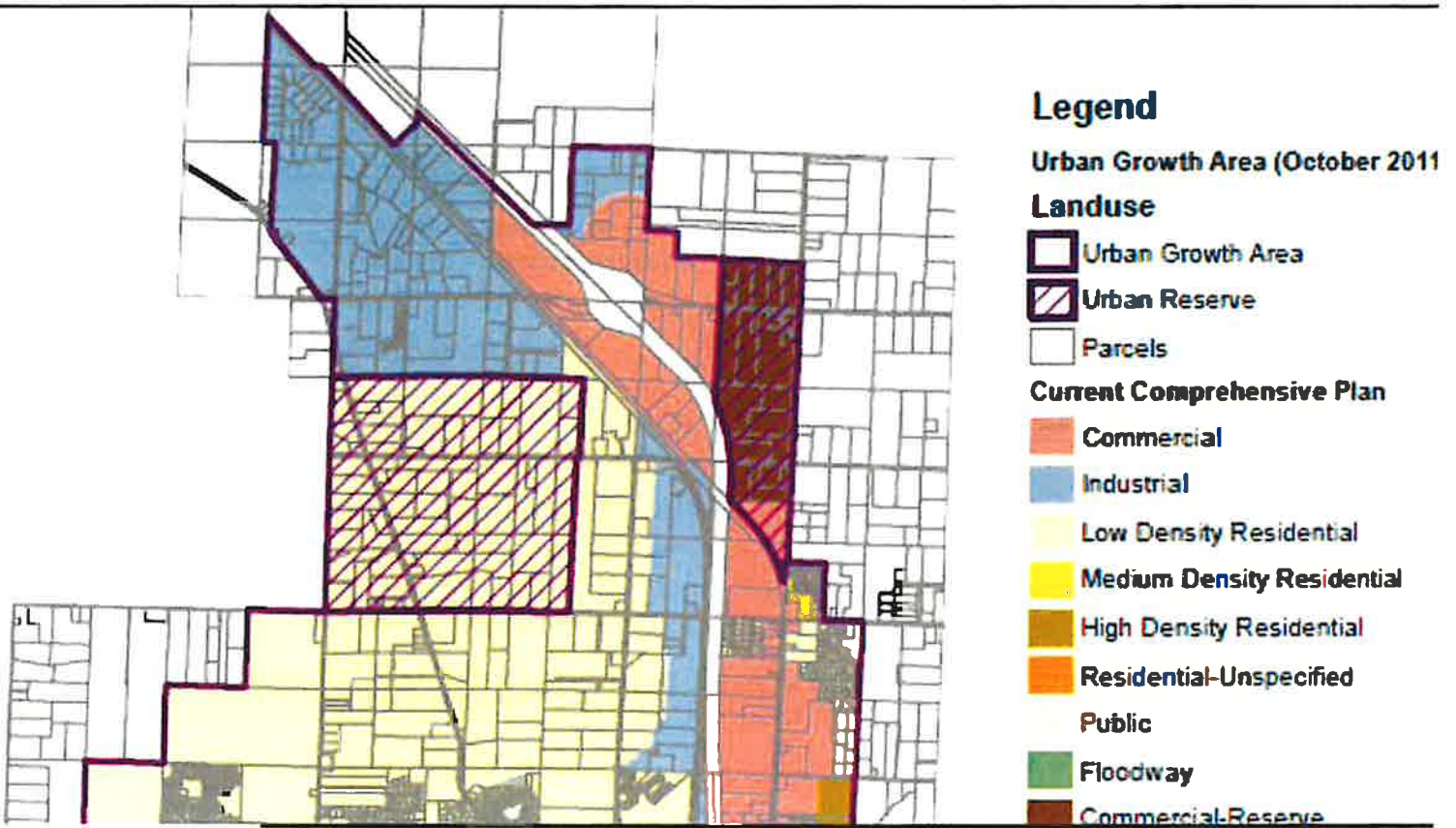

Allison Winterburn

Subject:

FW: Standing and flooding water

From: Chloe Pattenaude <chloepattenaude@gmail.com>
Date: May 11, 2022 at 1:11:14 PM PDT
To: Chris Pattenaude <bigasschev@aol.com>
Subject: Standing and flooding water

To whom this may concern,

I am writing this letter in regards to the industrial development that is going on in Ferndale, WA. Our property 7080 Atwood Rd. Ferndale, WA 98248 was here long before any of the industrial development. It has always had adequate drainage when it was just farm land but since the industrial development upstream has begun to occur we have been inundated by flood waters. The water floods our Well Head, saturates our entire property and septic field. We and our neighbors have grave concerns that the Toxic pollutants from the run off of the parking lots and industrial improvements are and will ruin our drinking water and land. We are in full support and look forward to working with the county water and Drainage to rectify the flooding problems. Attached are photos from this past winter of the water in our front and back yard which we have never seen until the industrial improvements were done.





Sincerely,
Christopher and Chloe Pattenaude
7080 Atwood rd
Ferndale, WA 98248
360.739.5708



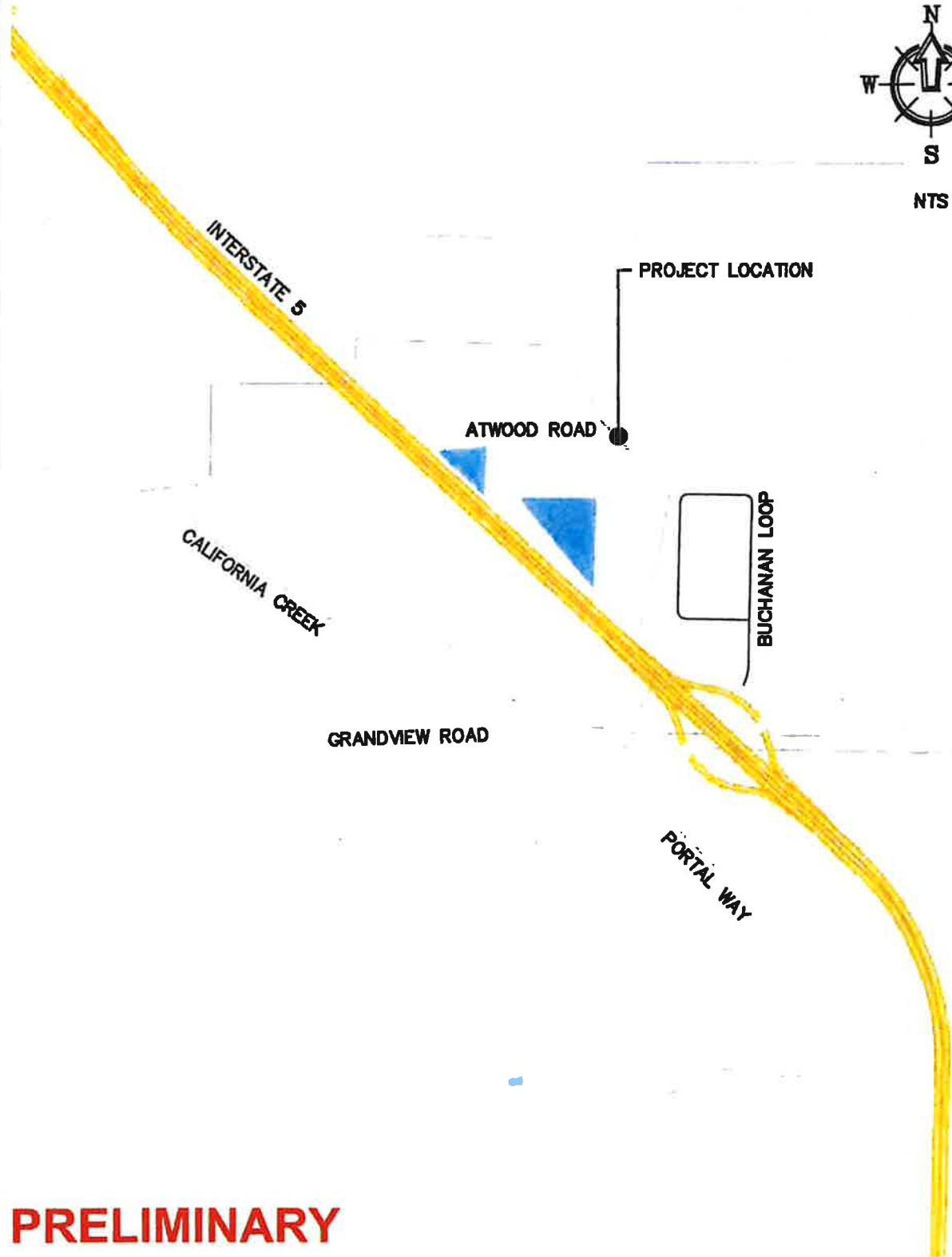
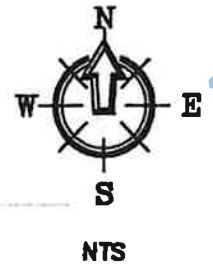

PRELIMINARY

ATWOOD ROAD BOX CULVERT

DRAINAGE IMPROVEMENT DISTRICT NO. 7
PROPOSED: BOX CULVERT
PURPOSE: ROAD STREAM CROSSING

VICINITY MAP

WHATCOM COUNTY
 WASHINGTON 98248
 SEC 6, T 39 N, R 2 E

APPLICANT: DRAINAGE IMPROVEMENT DISTRICT NO. 7

REFERENCE #:

WATERWAY: CALIFORNIA CREEK

DATE: 5/23/2022

PAGE: 1 Of 8

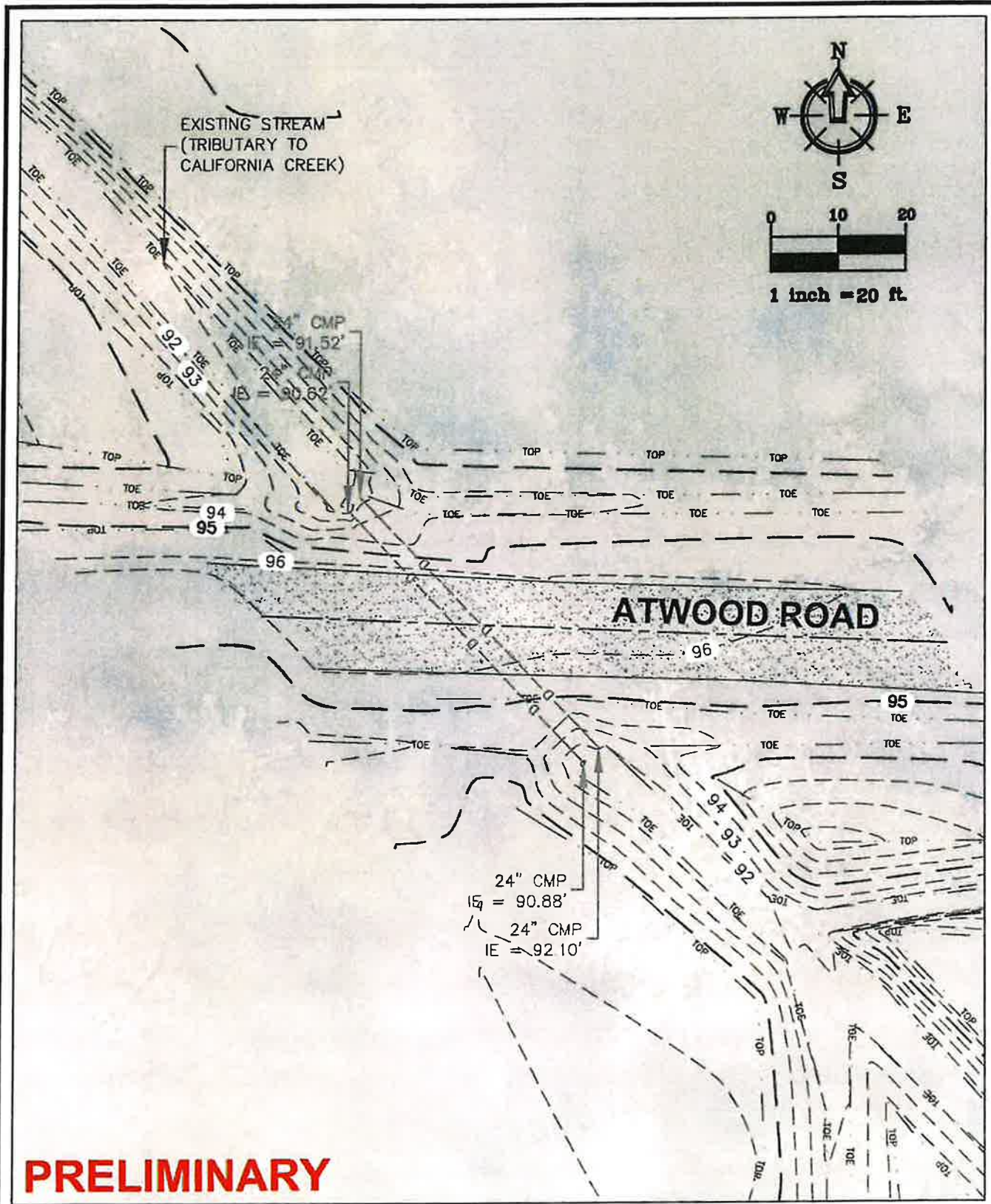

PRELIMINARY

ATWOOD ROAD BOX CULVERT DRAINAGE IMPROVEMENT DISTRICT NO. 7 PROPOSED: BOX CULVERT PURPOSE: ROAD STREAM CROSSING	EXISTING CONDITIONS WHATCOM COUNTY WASHINGTON 98248 SEC 6, T 39 N, R 2 E	APPLICANT: DRAINAGE IMPROVEMENT DISTRICT NO. 7	
		REFERENCE #:	
		WATERWAY: CALIFORNIA CREEK	
		DATE: 5/23/2022	PAGE: 2 Of 8

TESC LEGEND

- VEG** WSDOE BMP C101
PRESERVING NATURAL VEGETATION
- PS** WSDOE BMP C120
TEMPORARY AND PERMANENT SEEDING
- MU** WSDOE BMP C121
MULCHING
- DC** WSDOE BMP C140
DUST CONTROL
- SF** WSDOE BMP C233
SILT FENCE

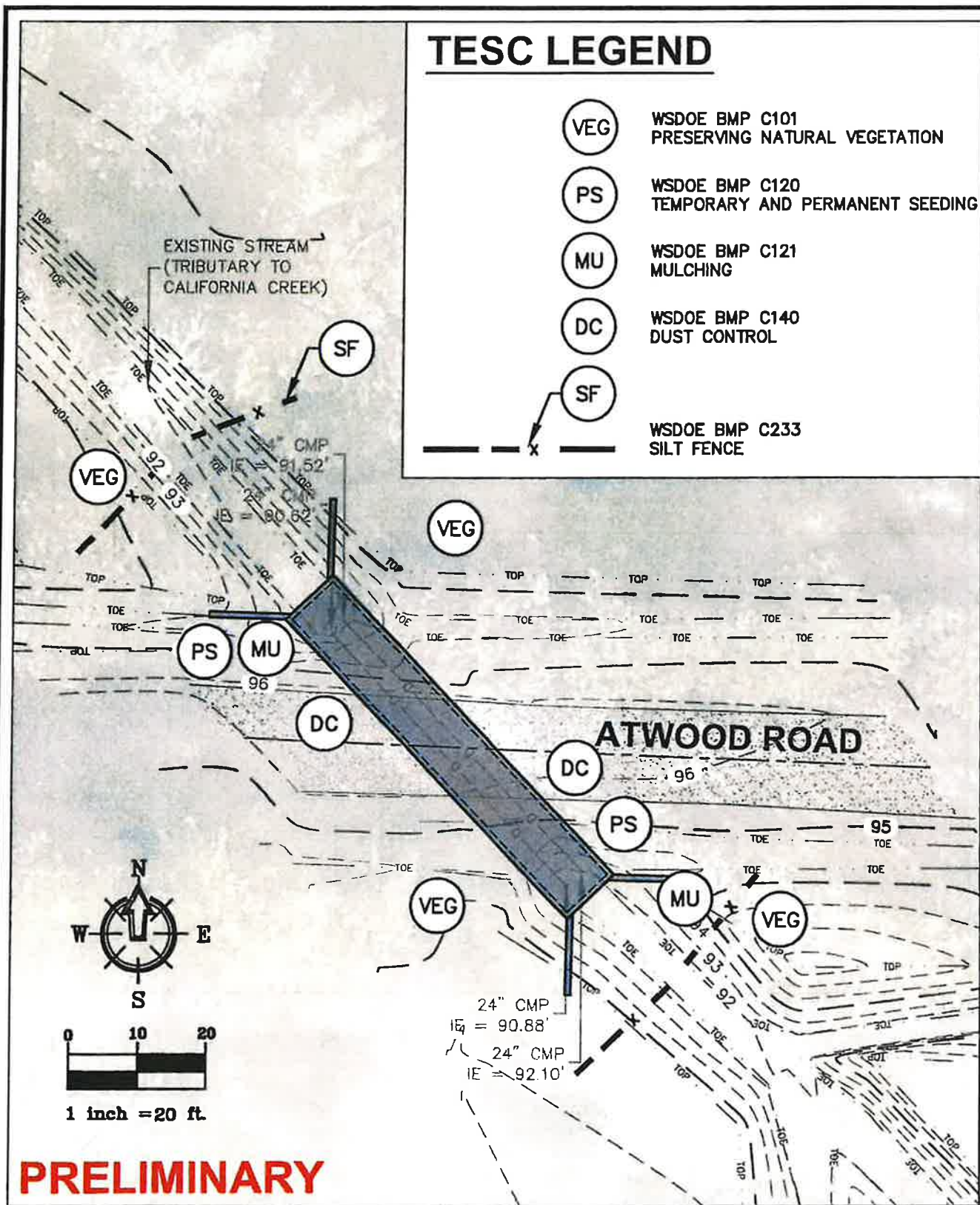

PRELIMINARY

ATWOOD ROAD BOX CULVERT

DRAINAGE IMPROVEMENT DISTRICT NO. 7
PROPOSED: BOX CULVERT
PURPOSE: ROAD STREAM CROSSING

TESC PLAN

WHATCOM COUNTY
 WASHINGTON 98248
 SEC 6, T 39 N, R 2 E

APPLICANT: DRAINAGE IMPROVEMENT DISTRICT NO. 7	
REFERENCE #:	
WATERWAY: CALIFORNIA CREEK	
DATE: 5/23/2022	PAGE: 3 Of 8

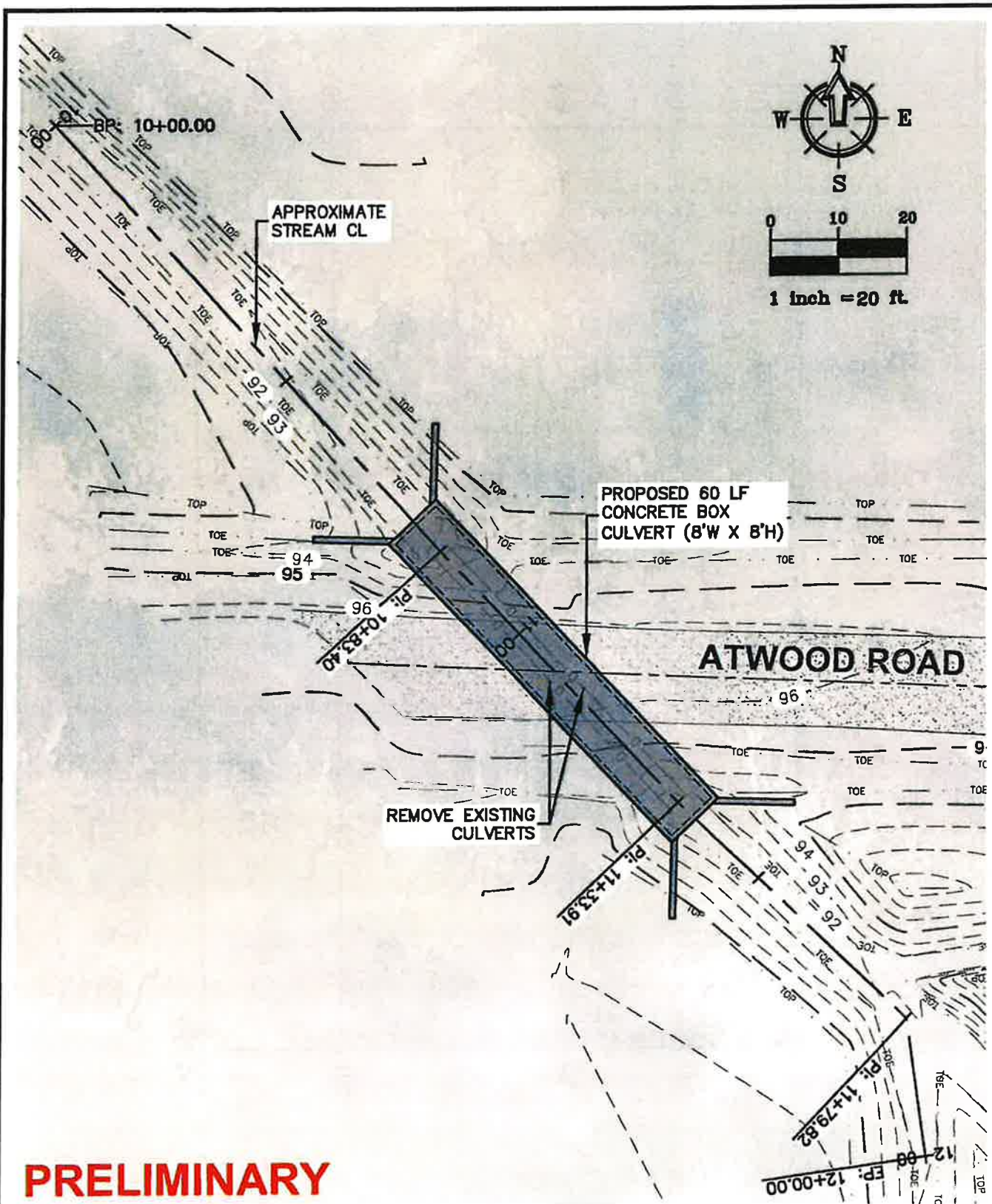

PRELIMINARY

ATWOOD ROAD BOX CULVERT DRAINAGE IMPROVEMENT DISTRICT NO. 7 PROPOSED: BOX CULVERT PURPOSE: ROAD STREAM CROSSING	SITE PLAN WHATCOM COUNTY WASHINGTON 98248 SEC 6, T 39 N, R 2 E	APPLICANT: DRAINAGE IMPROVEMENT DISTRICT NO. 7	
		REFERENCE #:	
		WATERWAY: CALIFORNIA CREEK	
		DATE: 5/23/2022	PAGE: 4 Of 8

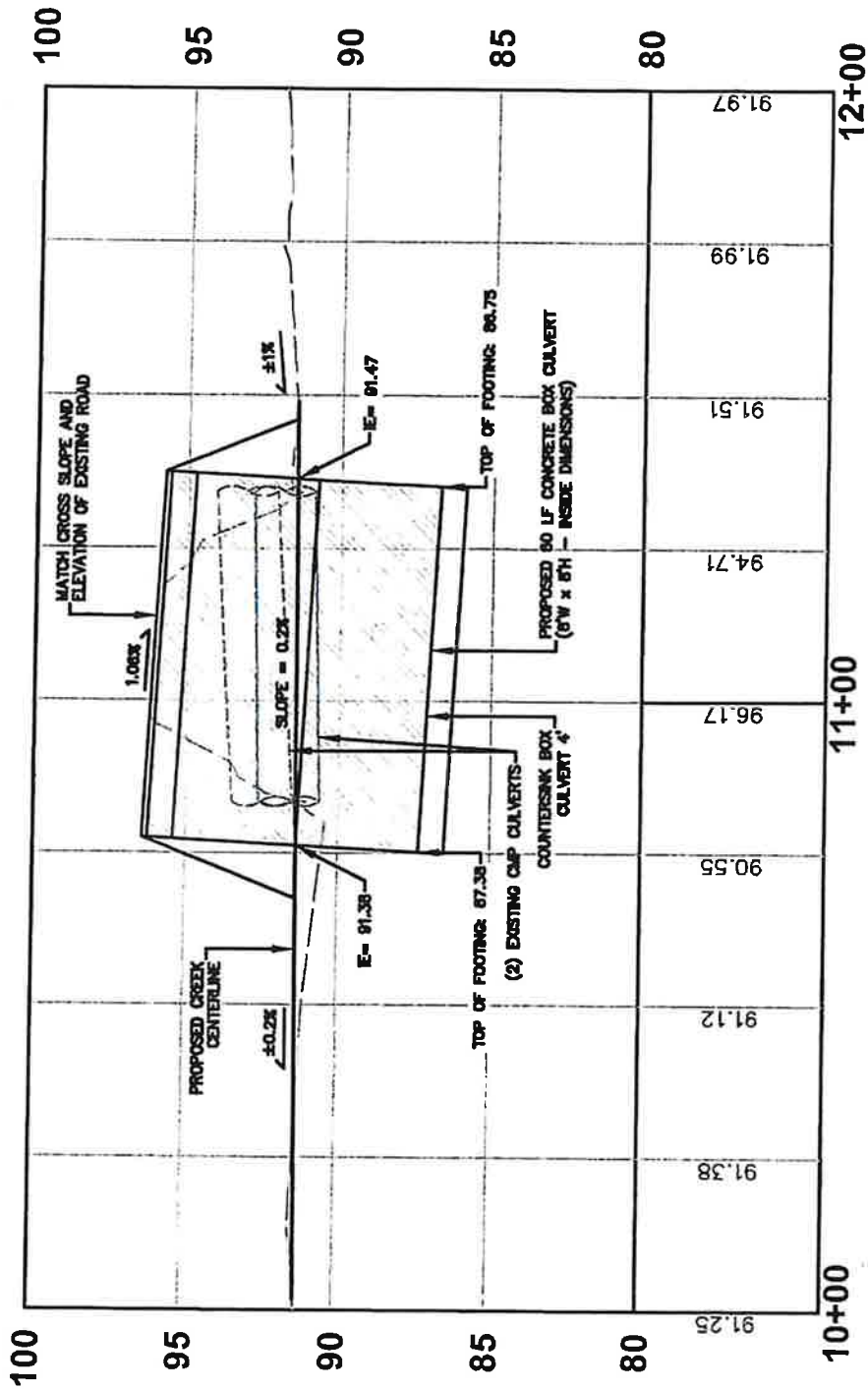

PRELIMINARY

ATWOOD ROAD BOX CULVERT

DRAINAGE IMPROVEMENT DISTRICT NO. 7
PROPOSED: BOX CULVERT
PURPOSE: ROAD STREAM CROSSING

BOX CULVERT SECTION A

WHATCOM COUNTY
 WASHINGTON 98248
 SEC 6, T 39 N, R 2 E

APPLICANT: DRAINAGE IMPROVEMENT DISTRICT NO. 7

REFERENCE #:

WATERWAY: CALIFORNIA CREEK

DATE: 5/23/2022

PAGE: 5 Of 8

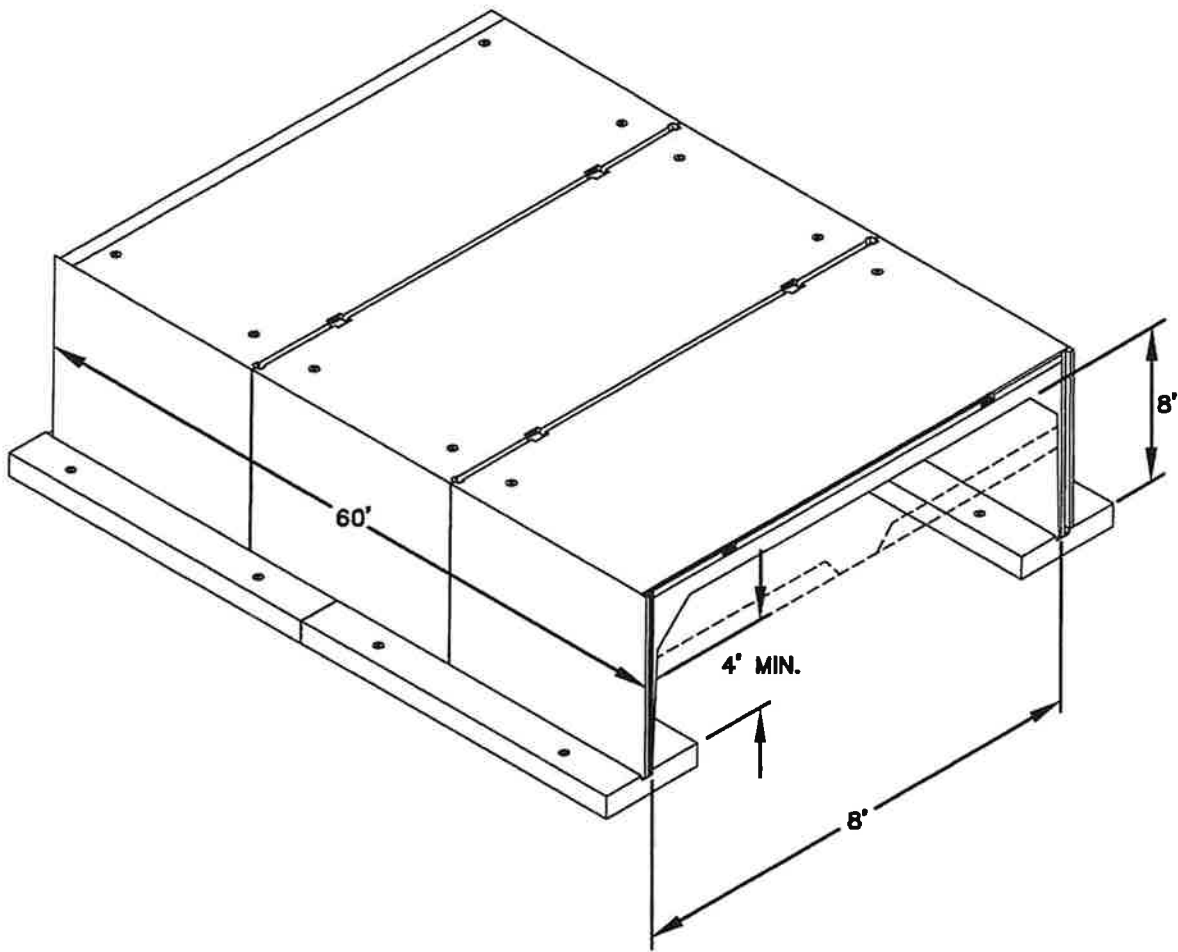

PRELIMINARY

ATWOOD ROAD BOX CULVERT

DRAINAGE IMPROVEMENT DISTRICT NO. 7
PROPOSED: BOX CULVERT
PURPOSE: ROAD STREAM CROSSING

BOX CULVERT SECTION B

WHATCOM COUNTY
 WASHINGTON 98248
 SEC 6, T 39 N, R 2 E

APPLICANT: DRAINAGE IMPROVEMENT DISTRICT NO. 7

REFERENCE #:

WATERWAY: CALIFORNIA CREEK

DATE: 5/23/2022

PAGE: 6 Of 8

STREAMBED SPECIFICATION

SIEVE SIZE	PERCENT PASSING
2 1/2" SQUARE	100
2" SQUARE	65-100
1" SQUARE	50-85
U.S. NO. 4	26-44
U.S. NO. 40	16 MAX.
U.S. NO. 200	5.0-9.0

STREAMBED SPECIFICATION NOTES:

1. ALL PERCENTAGES ARE BY MASS.
2. THE PORTION OF SEDIMENT RETAINED ON U.S. NO. 4 SIEVE SHALL NOT CONTAIN MORE THAN 0.2 PERCENT WOOD WASTE.
3. STREAMBED SPECIFICATION WSDOT 9-03.11(1)

HEAVY STREAMBED MIX

FOR PLACEMENT AT OUTSIDE CORNER MARGINS:

- 1 PART 6" COBBLE
 - 2 PARTS STREAMBED MATERIAL
- BOTH MEETING WSDOT STANDARD SPECIFICATIONS.

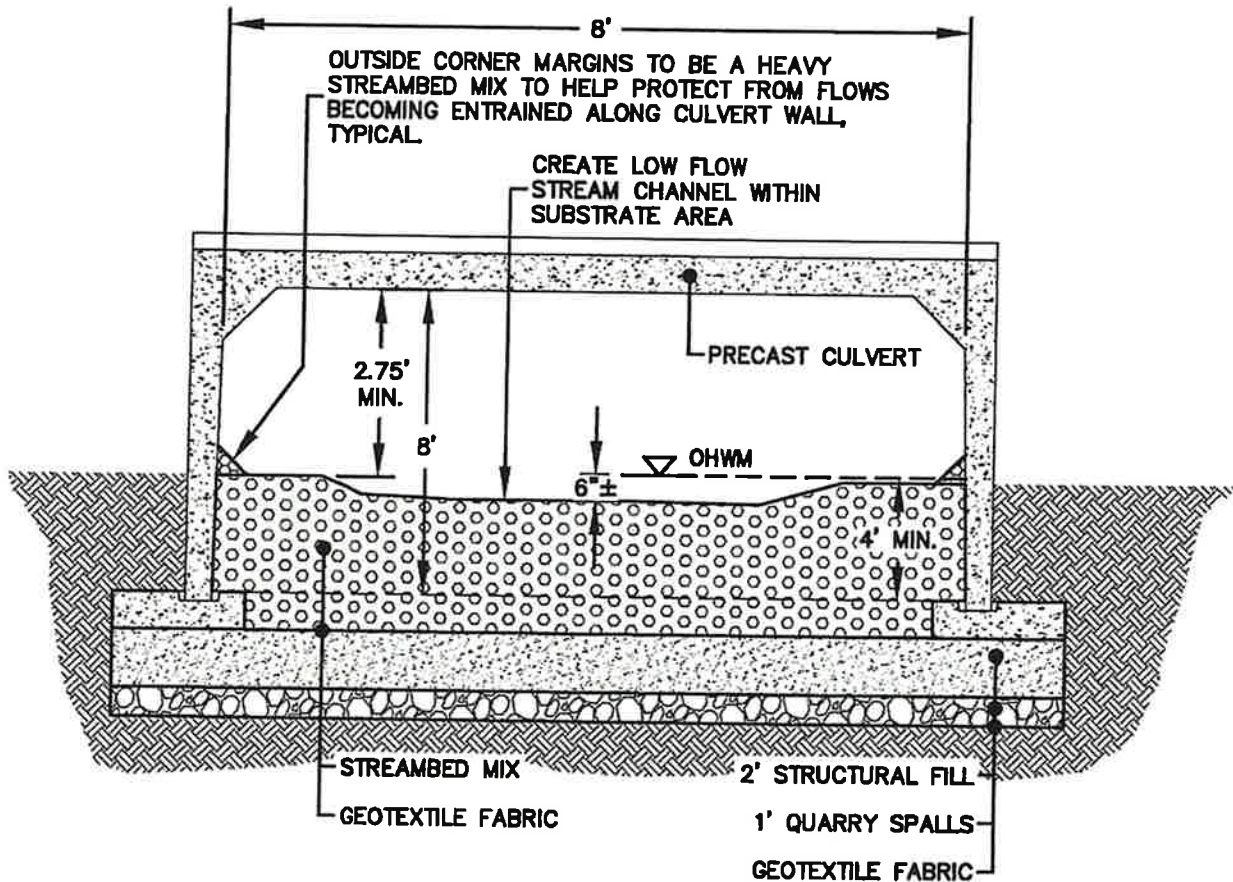

PRELIMINARY

ATWOOD ROAD BOX CULVERT

DRAINAGE IMPROVEMENT DISTRICT NO. 7
PROPOSED: BOX CULVERT
PURPOSE: ROAD STREAM CROSSING

BOX CULVERT SECTION C

WHATCOM COUNTY
 WASHINGTON 98248
 SEC 6, T 39 N, R 2 E

APPLICANT: DRAINAGE IMPROVEMENT DISTRICT NO. 7

REFERENCE #:

WATERWAY: CALIFORNIA CREEK

DATE: 5/23/2022

PAGE: 7 Of 8

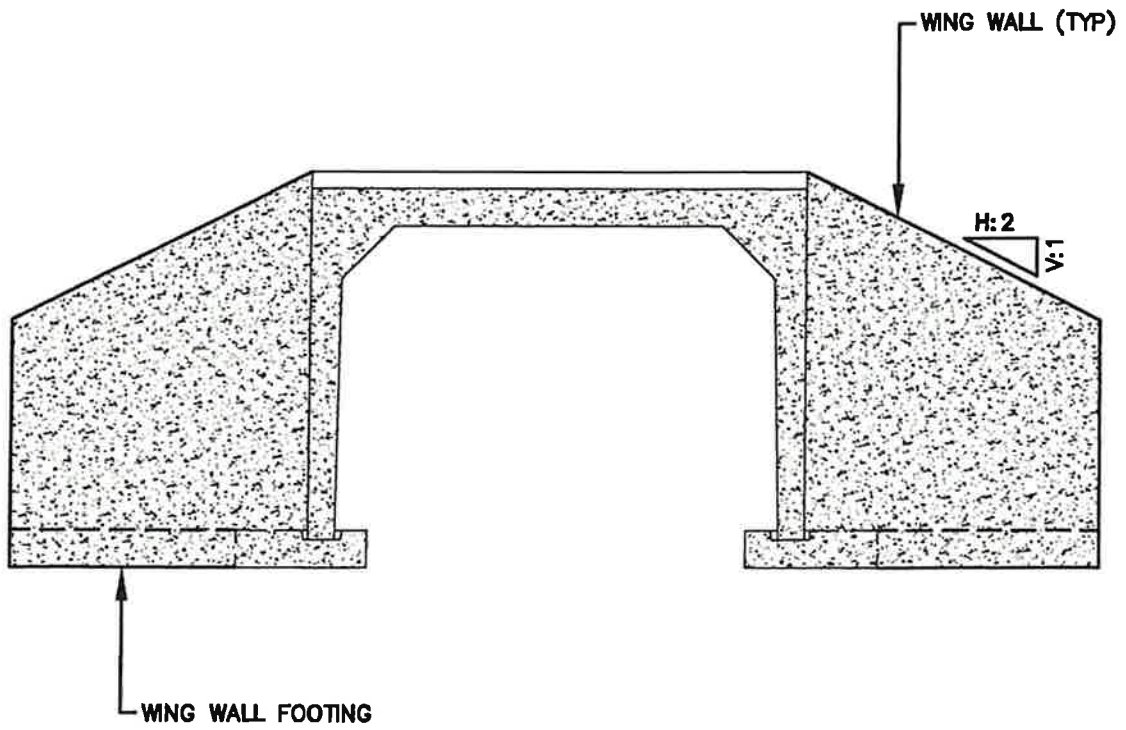

PRELIMINARY

ATWOOD ROAD BOX CULVERT DRAINAGE IMPROVEMENT DISTRICT NO. 7 PROPOSED: BOX CULVERT PURPOSE: ROAD STREAM CROSSING	BOX CULVERT WING WALL WHATCOM COUNTY WASHINGTON 98248 SEC 6, T 39 N, R 2 E	APPLICANT: DRAINAGE IMPROVEMENT DISTRICT NO. 7	
		REFERENCE #:	
		WATERWAY: CALIFORNIA CREEK	
		DATE: 5/23/2022	PAGE: 8 Of 8

